

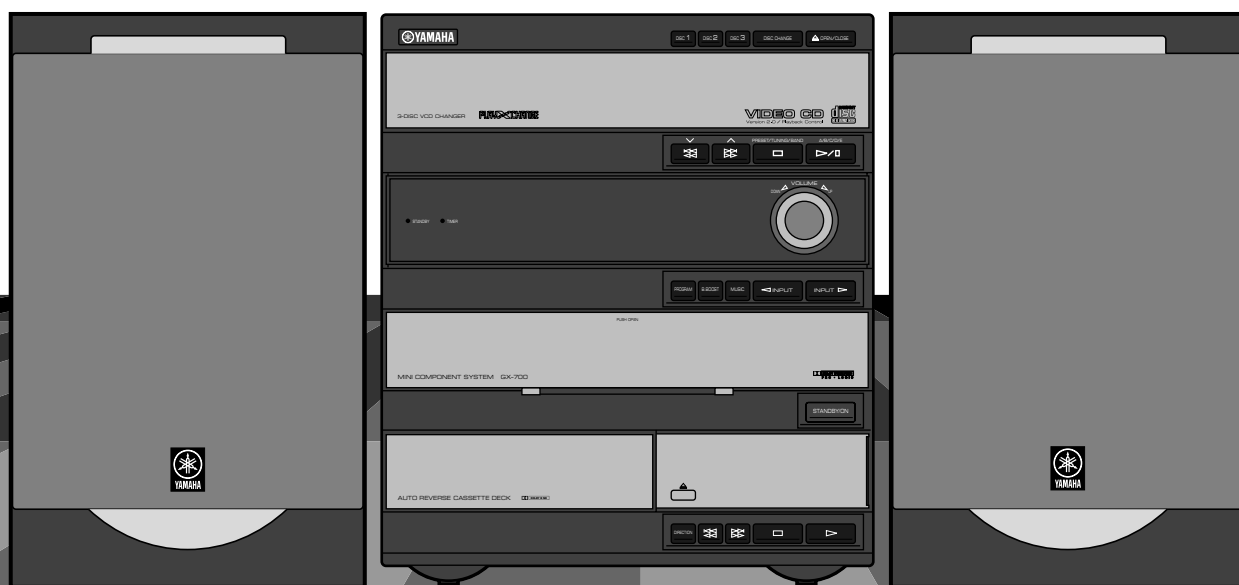

# GX-700VCD

*MINI COMPONENT SYSTEM*





*自然音响迷你组合系统*

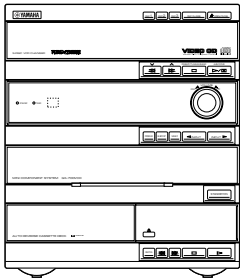
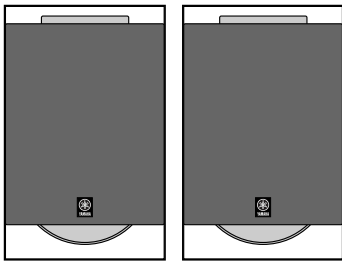
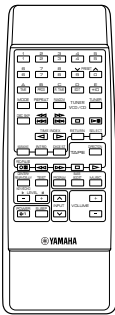

**OWNER'S MANUAL**  
**使用说明书**

## Unpacking 打开包装

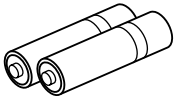
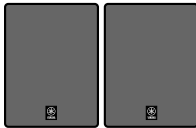
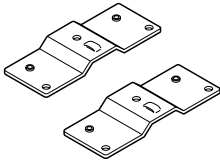
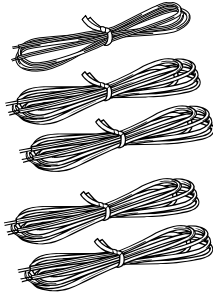
- After unpacking, check that the following parts are contained.
- 拆包后，请检查箱内是否配备下述附件。

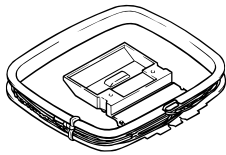
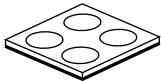
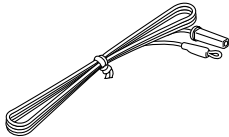
<ul style="list-style-type: none"> <li>● Main unit</li> <li>● 主装置</li> </ul>		<ul style="list-style-type: none"> <li>● Front speakers</li> <li>● 前置扬声器</li> </ul>	
<ul style="list-style-type: none"> <li>● Remote control</li> <li>● 遥控器</li> </ul>		<ul style="list-style-type: none"> <li>● Center speaker</li> <li>● 中置扬声器</li> </ul>	
<ul style="list-style-type: none"> <li>● Batteries (size AA, UM/SUM-3, R6, HP-7)</li> <li>● 电池 (尺寸：AA, UM/SUM-3, R6, HP-7)</li> </ul>		<ul style="list-style-type: none"> <li>● Rear speakers</li> <li>● 后置扬声器</li> </ul>	
<ul style="list-style-type: none"> <li>● Mounting brackets</li> <li>● 安装支架</li> </ul>		<ul style="list-style-type: none"> <li>● Speaker cords</li> <li>● 扬声器接线</li> </ul>	
<ul style="list-style-type: none"> <li>● Screws</li> <li>● 螺丝</li> </ul>		<ul style="list-style-type: none"> <li>● AM loop antenna</li> <li>● AM 环形天线</li> </ul>	
<ul style="list-style-type: none"> <li>● Pads</li> <li>● 护垫</li> </ul>		<ul style="list-style-type: none"> <li>● Indoor FM antenna</li> <li>● 室内 FM 天线</li> </ul>	

## Setting this system 设置本系统

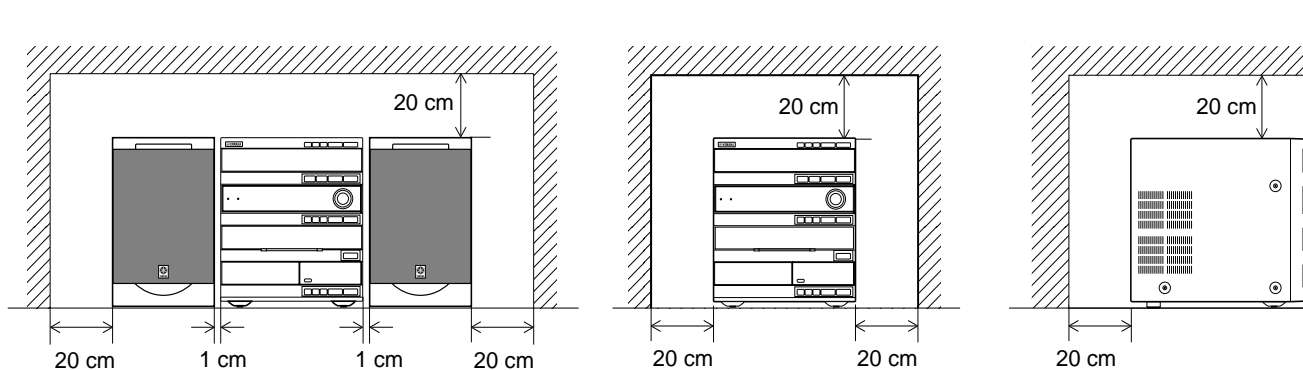

### English

Set this system allowing enough spaces around and behind the main unit to assure good ventilation. Be sure not to place another unit or any object on top of the main unit to prevent the ventilation holes from being obstructed. Otherwise, it may cause fire or damage to the main unit.

#### Note

When placing the speakers apart from the main unit, be sure to allow a space of at least 20 cm (3-15/16") above, behind and on both sides of the main unit. If the main unit is put in a rack, the front of it must be fully opened.

\* The values must be applied to China and Singapore models only.

### 中文

放置本系统时，为了确保通风良好，主装置的周围及其后面，应保持足够大的空间。在主装置上切勿放置其它装置或物品，防止堵塞主装置的通风口，否则可能引起火灾或对主装置造成损坏。

#### 注意

将扬声器与主装置分开放置，主装置的两侧，上方及其后面应保持20cm以上。如果将主装置放于架中，架子的前面必须完全开启。

\* 放置间距，将只适用于中国和新加坡机型。

# Front panel 前面板

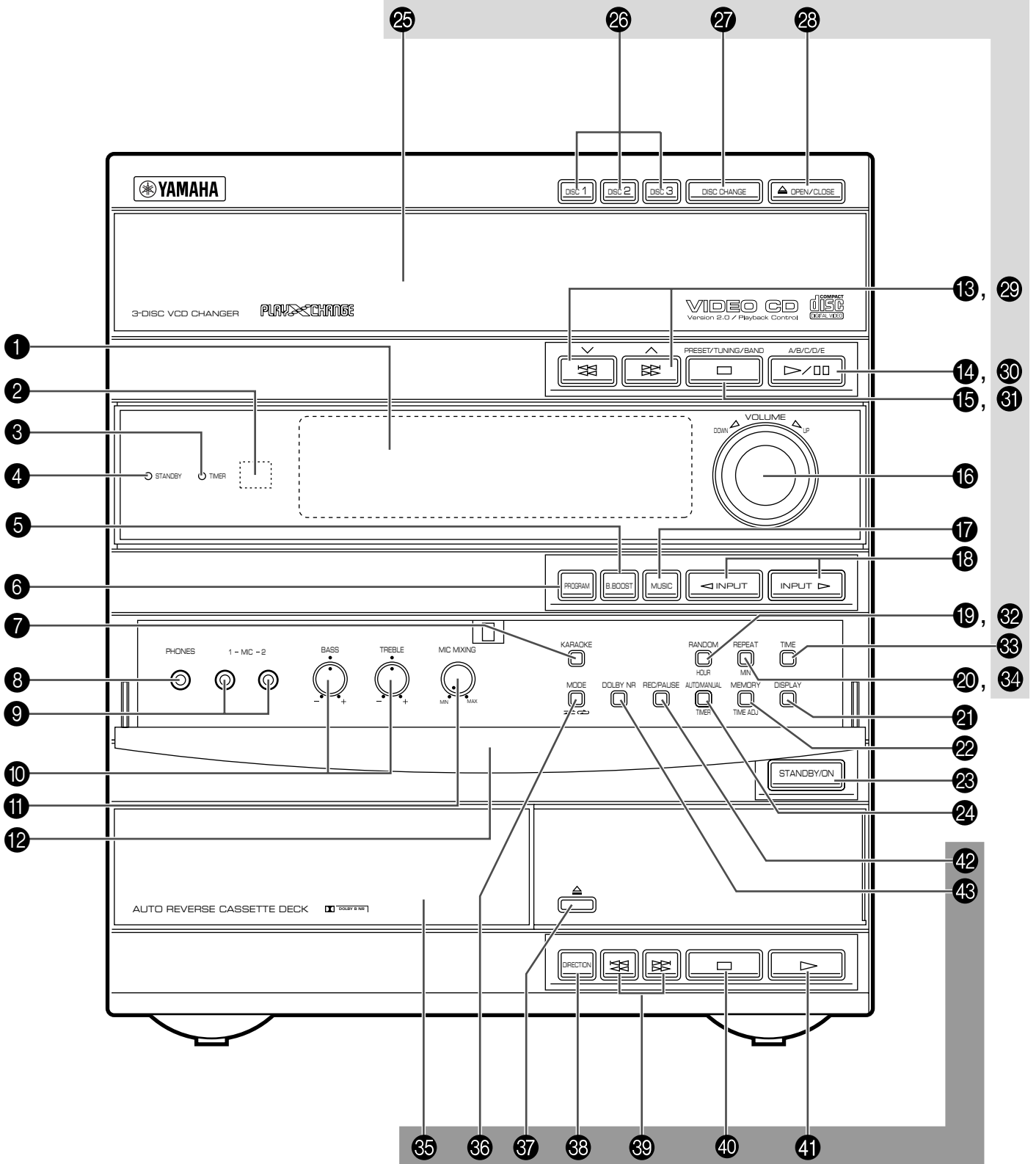

## Amplifier/tuner 放大器/调谐器

- |                                  |                                 |  |
|----------------------------------|---------------------------------|--|
| ① Display<br>显示窗                 | ⑨ MIC (1, 2) [p. 37]            | ⑱ INPUT(◀/▶) [p. 12, 21, 25, 31]<br>TUNER → TAPE → VCD/CD<br>↑ ↓<br>AUX/MD ← VCR ← VIDEO |
| ② Remote control sensor<br>遥控传感器 | ⑩ BASS/TREBLE [p. 32]           | ⑲ HOUR [p. 9, 39]  |
| ③ TIMER                          | ⑪ MIC MIXING [p. 37]            | ⑳ MIN [p. 9, 39]   |
| ④ STANDBY [p. 12]                | ⑫ Front cover<br>前盖             | ㉑ DISPLAY [p. 9, 39]   |
| ⑤ B. BOOST [p. 32]               | ⑬ ^/∨ [p. 21, 22]               | ㉒ MEMORY [p. 22, 23]<br>TIME ADJ [p. 9]  |
| ⑥ PROGRAM [p. 35]                | ⑭ A/B/C/D/E [p. 22]             | ㉓ STANDBY/ON<br>[p. 10]  |
| ⑦ KARAOKE [p. 37]                | ⑮ PRESET/TUNING/BAND<br>[p. 21] | ㉔ AUTO/MANUAL [p. 21]<br>TIMER [p. 39]   |
| ⑧ PHONES [p. 33]                 | ⑯ VOLUME [p. 32]                |  |
|                                  | ⑰ MUSIC [p. 33]                 |  |

## CD/Video CD player 镭射碟机/小影碟机

- |                                |                                  |                  |
|--------------------------------|----------------------------------|------------------|
| ⑳ Disc tray<br>碟片转盘<br>[p. 12] | ㉒ OPEN/CLOSE [p. 12]             | ㉔ RANDOM [p. 17] |
| ㉑ DISC (1, 2, 3) [p. 13]       | ㉓ ◀◀ (◀◀)/▶▶ (▶▶)<br>[p. 14, 19] | ㉕ TIME [p. 17]   |
| ㉒ DISC CHANGE [p. 14]          | ㉔ ▷/⏏ [p. 12]                    | ㉖ REPEAT [p. 16] |
|                                | ㉕ ◻ [p. 12]                      |                  |

## Tape deck 磁带录音座

- |                         |                           |                        |
|-------------------------|---------------------------|------------------------|
| ㉖ Tray<br>托盘<br>[p. 25] | ㉗ ≙ [p. 25]               | ㉙ ◻ [p. 25]            |
| ㉘ MODE [p. 25]          | ㉘ DIRECTION [p. 25]       | ㉚ ▷ [p. 25]            |
|                         | ㉙ ◀◀ (◀◀)/▶▶ (▶▶) [p. 26] | ㉛ REC/PAUSE [p. 27]    |
|                         |                           | ㉜ DOLBY NR [P. 24, 27] |

# Remote control 遥控器

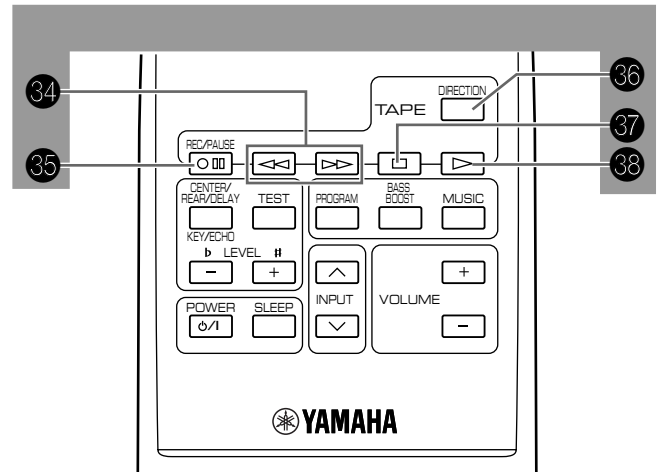
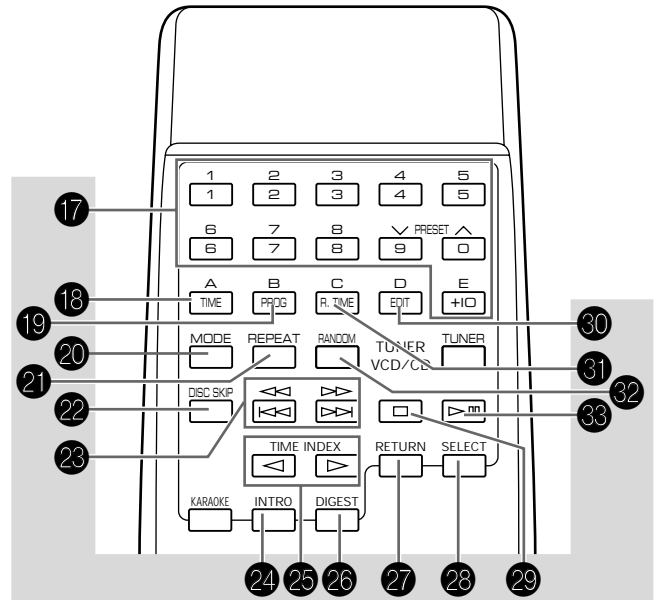
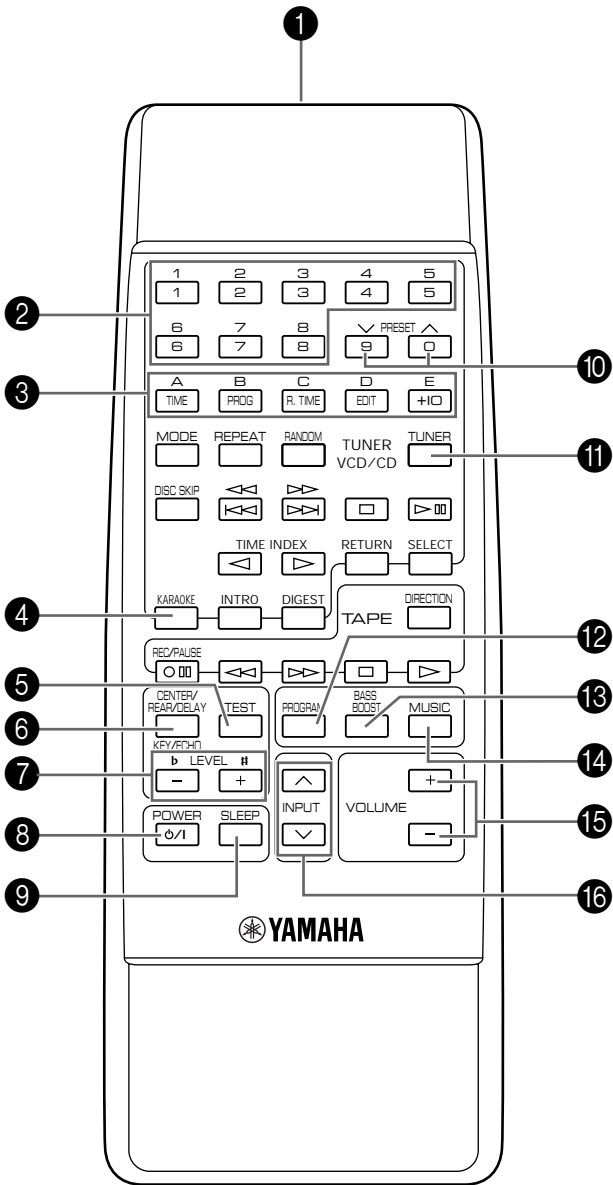

## Amplifier/tuner 放大器/调谐器

- ① Transmission window  
传递窗 [p. 4]
- ② Numeric buttons  
数字按钮 [p. 22]
- ③ A, B, C, D, E [p. 22]
- ④ KARAOKE [p. 37]
- ⑤ TEST [p. 10]
- ⑥ CENTER/REAR/DELAY [p. 36]  
KEY/ECHO [p. 38]
- ⑦ LEVEL (-/+) [p. 10, 36, 38]  
LEVEL ( / ) [p. 38]
- ⑧ POWER [p. 10]
- ⑨ SLEEP [p. 40]
- ⑩ PRESET ( / ) [p. 22]
- ⑪ TUNER [p. 21]
- ⑫ PROGRAM [p. 35]
- ⑬ BASS BOOST [p. 32]
- ⑭ MUSIC [p. 33]
- ⑮ VOLUME (+/-) [p. 32]
- ⑯ INPUT ( / ) [p. 12, 21, 25, 31]  
TUNER → TAPE → VCD/CD  
          ↑                  ↓  
AUX/MD ← VCR ← VIDEO

## CD/Video CD player 镭射碟机/小影碟机

- ⑰ Numeric buttons  
数字按钮 [p. 13]
- ⑱ TIME [p. 17]
- ⑲ PROG [p. 15]
- ⑳ MODE [p. 13]
- ㉑ REPEAT [p. 16]
- ㉒ DISC SKIP [p. 13]
- ㉓ ( ) / ( ) [p. 14, 19]
- ㉔ INTRO [p. 18]
- ㉕ TIME INDEX [p. 18]
- ㉖ DIGEST [p. 18]
- ㉗ RETURN [p. 19]
- ㉘ SELECT [p. 19]
- ㉙ [p. 12]
- ㉚ EDIT [p. 29, 30]
- ㉛ R. TIME [p. 29]
- ㉜ RANDOM [p. 17]
- ㉝ [p. 12]

## Tape deck 磁带录音座

- ⑳ / [p. 26]
- ㉑ REC/PAUSE [p. 27]
- ㉒ DIRECTION [p. 25]
- ㉓ [p. 25]
- ㉔ [p. 25]

# English

Thank you for purchasing this YAMAHA product. We hope it will give you many years of trouble-free enjoyment.  
For the best performance, read this manual carefully. It will guide you in operating your YAMAHA product.

## Contents

	Page
<b>Precautions</b> .....	<b>1</b>
<b>Features</b> .....	<b>3</b>
<b>Preparations and connections</b> .....	<b>4</b>
Installing batteries in the remote control .....	4
Remote control operation range .....	4
Setting the video output format selector (TV MODE) switch .....	4
Setting up the speakers .....	5
Connections .....	7
Setting the clock .....	9
Adjusting brightness of the display .....	9
Speaker balance adjustment .....	10
<b>CD/Video CD player operation</b> .....	<b>11</b>
Basic play .....	12
To change the disc play mode .....	13
To select another disc .....	13
To select the desired track directly .....	13
To play the desired track (Skip) .....	14
To advance or reverse play rapidly (Search) .....	14
To exchange a disc (or discs) while playing (PLAYXCHANGE) .....	14
Program play .....	15
Repeat play .....	16
Random play .....	17
Switching the time display .....	17
To find your desired scene quickly	
<b>for Video CDs</b> .....	18
To get a quick overview of a track or a disc	
<b>for Video CDs</b> .....	18
Playback Control of Video CD (version 2.0)	
<b>for Video CDs</b> .....	19

	Page
<b>Tuning operation</b> .....	<b>20</b>
Automatic tuning .....	21
Manual tuning .....	21
Manual preset tuning .....	22
Automatic preset tuning .....	23
<b>Playing back a tape</b> .....	<b>24</b>
General information .....	24
Basic operation .....	25
Winding the tape .....	26
Searching for the beginning of the desired selection .....	26
<b>Recording</b> .....	<b>27</b>
Basic recording .....	27
Recording from CDs utilizing the EDIT function .....	29
<b>Operating an external unit connected with this system</b> .....	<b>31</b>
<b>Various sound control</b> .....	<b>32</b>
General sound control .....	32
Graphic equalizer .....	33
Sound field processor .....	34
<b>Karaoke operation</b> .....	<b>37</b>
<b>Using the built-in timer</b> .....	<b>39</b>
Timer play .....	39
Timer recording .....	40
Sleep timer operation .....	40
<b>Appendix</b> .....	<b>41</b>
Troubleshooting .....	41
Specifications .....	43

For basic source play, the following illustrations on top of pages will help you to look for the section you need.



..... CD/Video CD play



..... Tuning



..... Tape playback/recording



# Precautions: Read this before operating your system

- To assure the finest performance, please read this manual carefully. Keep it in a safe place for future reference.
- Choose the installation location of this system carefully. Avoid placing it in direct sunlight or close to a source of heat. Also avoid locations subject to vibration and excessive dust, heat, cold or moisture. Keep it away from sources of hum such as transformers and electric motors.
- Do not operate this system upside-down. It may overheat, possibly causing damage.
- Never open the cabinet. If something drops into the set, contact your dealer.
- The openings on the main unit cover assure proper ventilation of the main unit. If these openings are obstructed, the temperature inside the main unit will rise rapidly. Therefore, avoid placing objects against these openings, and install the main unit in a well-ventilated area to prevent fire and damage.
- Always set the VOLUME control to minimum before starting an audio source play: increase the volume gradually to an appropriate level after play has started.
- When not planning to use this system for long periods of time (ie., vacation, etc.), disconnect the AC power plug from the wall outlet.
- Grounding or polarization – Precautions should be taken so that the grounding or polarization of this system is not defeated.
- Do not use force on switches, controls or connection wires. When moving the main unit, first disconnect the power plug and the wires connected to other equipment. Never pull the wire itself.
- If an external appliance (TV, radio, etc.) interferes with this system operation, move the main unit away from such an appliance.
- Do not attempt to clean this system with chemical solvents; this might damage the finish. Use a clean, dry cloth.
- Be sure to read the “Troubleshooting” section regarding common operating errors before concluding that this system is faulty.
- To prevent lightning damage, disconnect the AC power plug and the antenna cable when there is an electrical storm.
- Do not plug the AC power plug to the wall socket before you finish all connections.
- Never allow metallic items (e.g. screwdrivers, tools, etc.) to come near the tape deck’s record/playback head assembly. Doing so may not only scratch or damage the head’s mirror-smooth finish, it may change the magnetic characteristics of the heads, causing a deterioration in reproduction performance quality.
- Although the tape deck’s record/playback heads are high quality heads with outstanding reproduction characteristics, they can become dirty through the use of old tapes or from dust accumulation over time. This can have a serious effect on reproduction quality. Clean the heads regularly with one of the commonly available head cleaners or with cleaning solutions.
- The voltage to be used must be the same as that specified on this system. Using this system with a higher voltage than specified is dangerous and may result in a fire or other types of accidents causing damage. YAMAHA will not be held responsible for any damage resulting from use of this system with a voltage other than specified.
- The sound level at a given volume setting depends on speaker location and other factors. Care should be taken to avoid exposure to sudden high levels of sound, which may occur when turning on this system with the volume control setting at high, and to continuous high levels of sound.
- Sudden temperature changes and storage or operation in an extremely humid environment may cause condensation inside the cabinet. Condensation can cause this system to malfunction.  
  
To eliminate condensation:
  - **Pickup**  
Leave the power on with no disc loaded until normal play becomes possible (about 1 hour).
  - **Tape head**  
Leave the power on with no tape loaded until normal playback becomes possible (about 1 hour).  
**Note**  
If condensation forms on the tape head, dirt or dust may accumulate during use.
  - **Remote control**  
Wipe off condensation on the transmission window with a soft cloth before operating this system.
- To prevent a malfunction of this system:
  - Do not use any non standard shaped disc (heart etc.) available on the market, because it may damage this system.
  - Do not use a disc with tape, seals, or paste on it, because damage to this system may result.

## IMPORTANT

Please record the serial number of this system in the space below.

Model:

Serial No.:

The serial number is located on the rear of the main unit. Retain this Owner’s Manual in a safe place for future reference.

## WARNING

TO REDUCE THE RISK OF FIRE OR ELECTRIC SHOCK, DO NOT EXPOSE THIS APPLIANCE TO RAIN OR MOISTURE.

## Precautions: Read this before operating your system

This system is not disconnected from the AC power source as long as it is connected to the wall outlet, even if this system itself is turned off. This state is called the standby mode.  
In this state, this system is designed to consume a certain level of power.

### Note

Please check the copyright laws in your country to record from records, compact discs, radio, etc. Recording of copyright material may infringe copyright laws.

### CAUTION FOR CARRYING THE MAIN UNIT

Be sure not to carry or tip the main unit with discs remaining in it.

### CAUTION FOR MOVING THE MAIN UNIT

Before moving the main unit, first remove all discs from the disc tray and close the tray by pressing the **OPEN/CLOSE** button. After you confirm that "NO DISC" lights up on the display, turn this system into the standby mode by pressing the **STANDBY/ON** switch, and then disconnect the power plug from the AC outlet.

### Voltage Selector (China and General models only)

The voltage selector on the rear panel of the main unit must be set for your local main voltage **BEFORE** plugging into the AC main supply.  
Voltages are 110/120/220/240 V AC, 50/60 Hz.

### FREQUENCY STEP switch (China and General models only)

Because the interstation frequency spacing differs in different areas, set the **FREQUENCY STEP** switch (located at the rear) according to the frequency spacing in your area.

Be sure to change the setting of this switch with the AC supply lead of this system disconnected from the AC outlet.

## WARNING

To reduce the risk of fire or electric shock, do not expose this system to rain or moisture.

To avoid electrical shock, do not open the cabinet. Refer servicing to qualified personnel only.

### CAUTION

Use of controls or adjustments or performance of procedures other than those specified herein may result in hazardous radiation exposure.

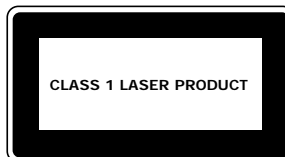

As the laser beam used in this unit is harmful to the eyes, do not attempt to disassemble the cabinet. Refer servicing to qualified personnel only.



This system is classified as a CLASS 1 LASER product. The CLASS 1 LASER PRODUCT label is located on the rear exterior.

Laser component in this product is capable of emitting radiation exceeding the limit for Class 1.

### The CD/Video CD player in this system can play discs of the following types only.

Type of disc	Mark printed on the disc	Type of signal recorded	Size (Dimension)	Maximum possible play time
<b>Video CD</b>	 	Sound + Picture (Movie)	12 cm	74 minutes
			8 cm (Single type)	20 minutes
<b>CD</b>		Sound only	12 cm	74 minutes
			8 cm (Single type)	20 minutes

Never attempt to play a disc other than above with the CD/Video CD player because it may cause a damage to this system.

### VIDEO CD

Video CDs are classified into two types, version 1.1 and 2.0. The CD/Video CD player can play both types.

**Video CD (version 1.1):** With the same operation as compact discs, you can enjoy sounds and pictures (movies).

**Video CD (version 2.0):** In addition to a normal play which is the same as version 1.1, you can enjoy a Playback Control operation. (For details on Playback Control, refer to page 19.)

## General

- **5-Speaker Multichannel Audio System**  
(Two front, One Center and Two Rear Speakers)
- **High Power Output**  
Front L, R: 100W + 100W (6Ω) RMS, 10% THD, 1 kHz  
Center: 100W (6Ω) RMS Output Power, 10% THD, 1 kHz  
Rear: 30W (6Ω) RMS Output Power, 10% THD, 1 kHz
- **4 External Audio/Video Component Connecting Capability**
- **Multiuse Timer/Sleep Timer**
- **SUBWOOFER Output for Low Frequency Expansion**
- **Remote Control Capability**
- **BASS BOOST**
- **5-Band Spectrum Analyzer**
- **DOLBY PRO LOGIC and DOLBY 3 STEREO Decoding**
- **Sound Field Processing (HALL and YMERISION)**
- **Test Tone Generator for Easier Speaker Balance Adjustment**
- **3 Preset Graphic Equalizer Modes (ROCK, POPS and JAZZ)**
- **Video Output Format Selector (TV MODE) Switch**

## CD/Video CD Player

- **3-Disc Carousel Auto-Changer for Video CDs and Compact Discs**
- **PLAYXCHANGE**  
Disc changing while playing
- **20-Track Random Access Programming**
- **Repeat Play for Single Track/Entire Disc/ All Discs**
- **Random Sequence Play**
- **Playback Control Function Available for Video CD (version 2.0)**
- **Quick Overview of a Track and a Disc with a Touch of the DIGEST and INTRO Buttons**
- **Time Index Function**

## Tape Deck

- **Automatic Synchronized Recording with CD or Video CD**
- **EDIT Function Useful for Recording CD(s)**
- **Automatic Reverse**
- **Dolby B Type Noise Reduction System**

## Tuner

- **40 Station Preset Tuning**
- **Automatic Preset Tuning**

## Karaoke-functions

- **4 Modes for Singing Karaoke**
- **2 Microphone Connecting Capability**
- **Mic Mixing, Echo Level and Key Control Capability**
- **Karaoke Sound Recording Capability (Recording Your Singing Voice and Karaoke Effects with the Music Source)**

# Preparations and connections

## Installing batteries in the remote control

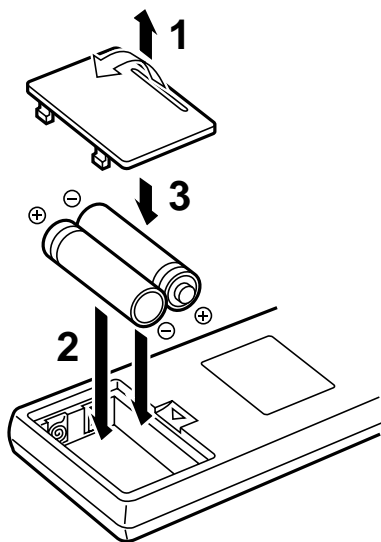

1. Turn the remote control over and remove the battery compartment cover by pulling it up while pressing the edge of the cover in the direction of the  $\nabla$  mark.
2. Insert the batteries (AA, R6, UM-3 type) according to the polarity markings on the inside of the battery compartment.
3. Attach the battery compartment cover.

### Notes

- Remove the batteries if the remote control is not used for an extended period of time.
- If batteries leak, dispose of them immediately. Avoid touching the leaked material and contact with clothing, etc. Clean the battery compartment thoroughly before installing new batteries.
- Be sure to use the same type of batteries together.
- Do not use a new battery and an old battery together.

## Remote control operation range

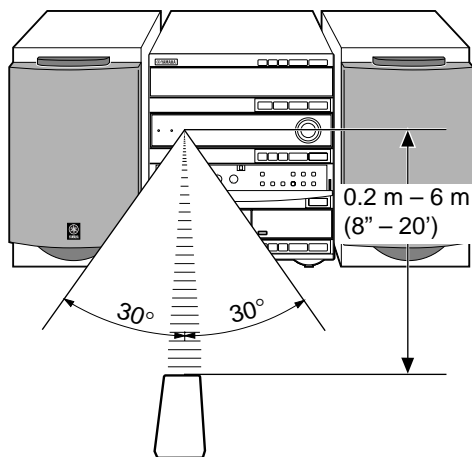

### Notes

- The area between the remote control and the main unit must be clear of large obstacles.
- Do not expose the remote control sensor to strong lighting, in particular, an inverter type fluorescent lamp. Otherwise, the remote control may not work properly. If necessary, position the main unit away from direct lighting.

### Battery replacement

If you find that the remote control must be used closer to the main unit, the batteries are weak. Replace both batteries with new ones.

## Setting the video output format selector (TV MODE) switch

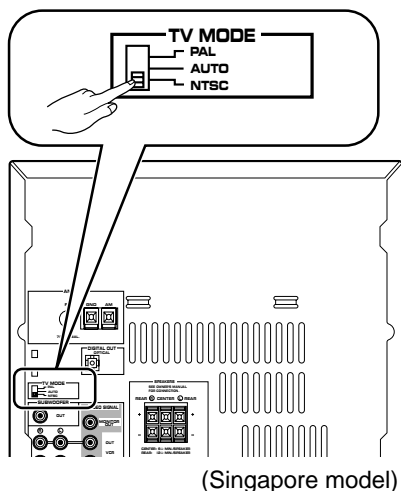

This system is designed for use with the NTSC and PAL television formats. Set this switch to the position for the format your TV monitor employs.

- PAL:** Set to this position if your TV monitor employs the PAL format.
- AUTO:** Set to this position if your TV monitor can be switched in between the PAL and NTSC formats automatically.
- NTSC:** Set to this position if your TV monitor employs the NTSC format.

## Setting up the speakers

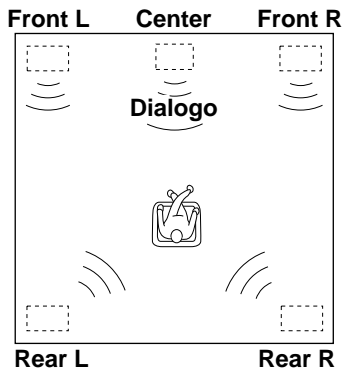

### ■ 4 channel 5 speaker configuration

This system employs a 5 speaker configuration: 2 front speakers, 2 rear paralleled speakers and a center speaker. The front speakers are used for outputting main source sound. The rear speakers are for effect and surround sounds when the sound field program  **PRO LOGIC** or **HALL** is selected. The center speaker is for center sounds (dialog etc.) when the sound field program  **PRO LOGIC** or  **3 STEREO** is selected.

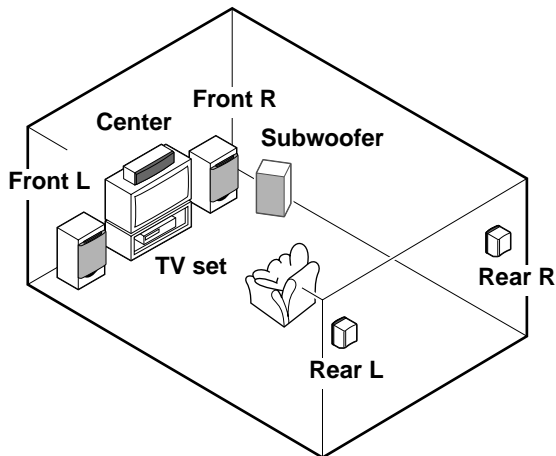

### ■ Placing the speakers

- Front speakers:** On both sides of the TV and almost the same height as the TV.
- Center speaker:** Precisely between the front speakers.
- Rear speakers:** Behind your listening position, facing slightly inward. Nearly 1.8 m (approx. six feet) up from the floor.
- Subwoofer:** The position of the subwoofer is not so critical because low bass tones are not highly directional.  
(separate purchase)

### ■ Mounting the center speaker

Place the center speaker on the TV, on the floor under the TV or in the TV rack so that it is stabilized. When placing the speaker on top of the TV, to prevent the speaker from falling down, put the provided pads at four points on bottom of the speaker.

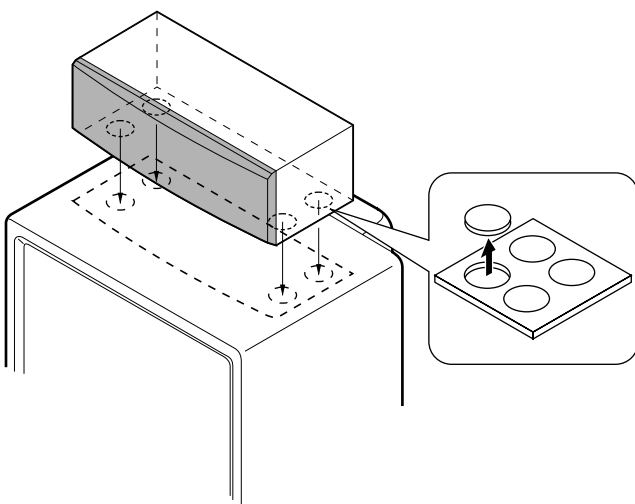

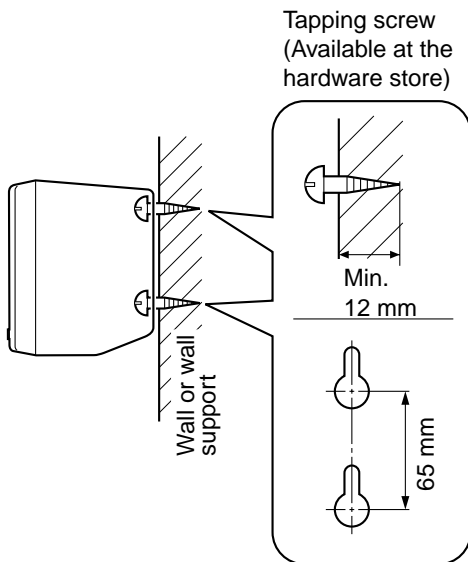
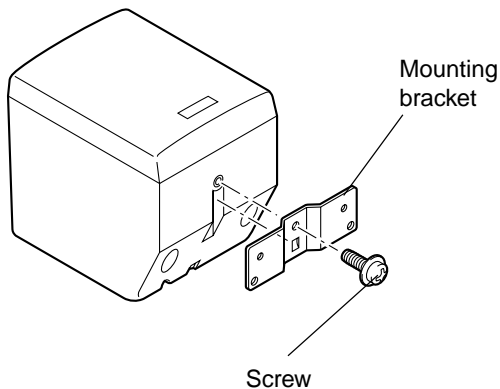
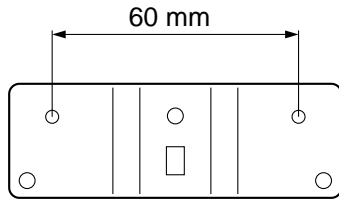

### ■ Mounting the rear speakers

Mount the rear speakers on a shelf, rack or on the floor, or hang them on the wall.

#### To mount the rear speakers on the wall by using commercially available speaker stands

The provided mounting bracket has 1 pair of screw holes (at an interval of 60 mm). They are available for mounting the speaker on a speaker stand.

\* Those screw holes can be used with M4 screws only.

#### Note

It is recommended that you connect the speaker cords to the speaker's terminals before attaching the bracket to the speaker.

- 1 Attach the bracket to the bottom of the speaker by using the provided screw so that the convex part of the bracket fits in the grooved part of the speaker as figured left.
- 2 Mount the speaker on the speaker stand by using the screw holes on the bracket.

#### To mount the rear speakers on the wall without using any bracket or stand

If desired, you can hang the speaker on the protruding screws on the wall without using the bracket.

Fasten screws into a firm wall or wall support as figured left, and hang the holes of the speaker on the protruding screws.

\* Make sure that the screws are caught by a narrow part of the holes securely.

#### WARNING:

- Each of the rear speakers weighs 0.8 kg (1 lbs. 12 oz.). Do not mount them on thin plywood or soft wall surface material, as the screws may come out of the flimsy surface, causing the speakers to fall down and be damaged, or result in personal injury.
- Do not fasten the speakers to the wall with nails, adhesives, or other unsound hardware. Long-term use and vibrations may cause them to fall down.
- To avoid accidents resulting from tripping over loose speaker cords, fix them to the wall.
- Select a proper position on the wall to mount the speaker and the stand so that no one will hit his head or forehead on the projections of them, resulting in personal injury.

## Connections

Never plug the AC supply lead of this system into the AC outlet until all connections are completed.

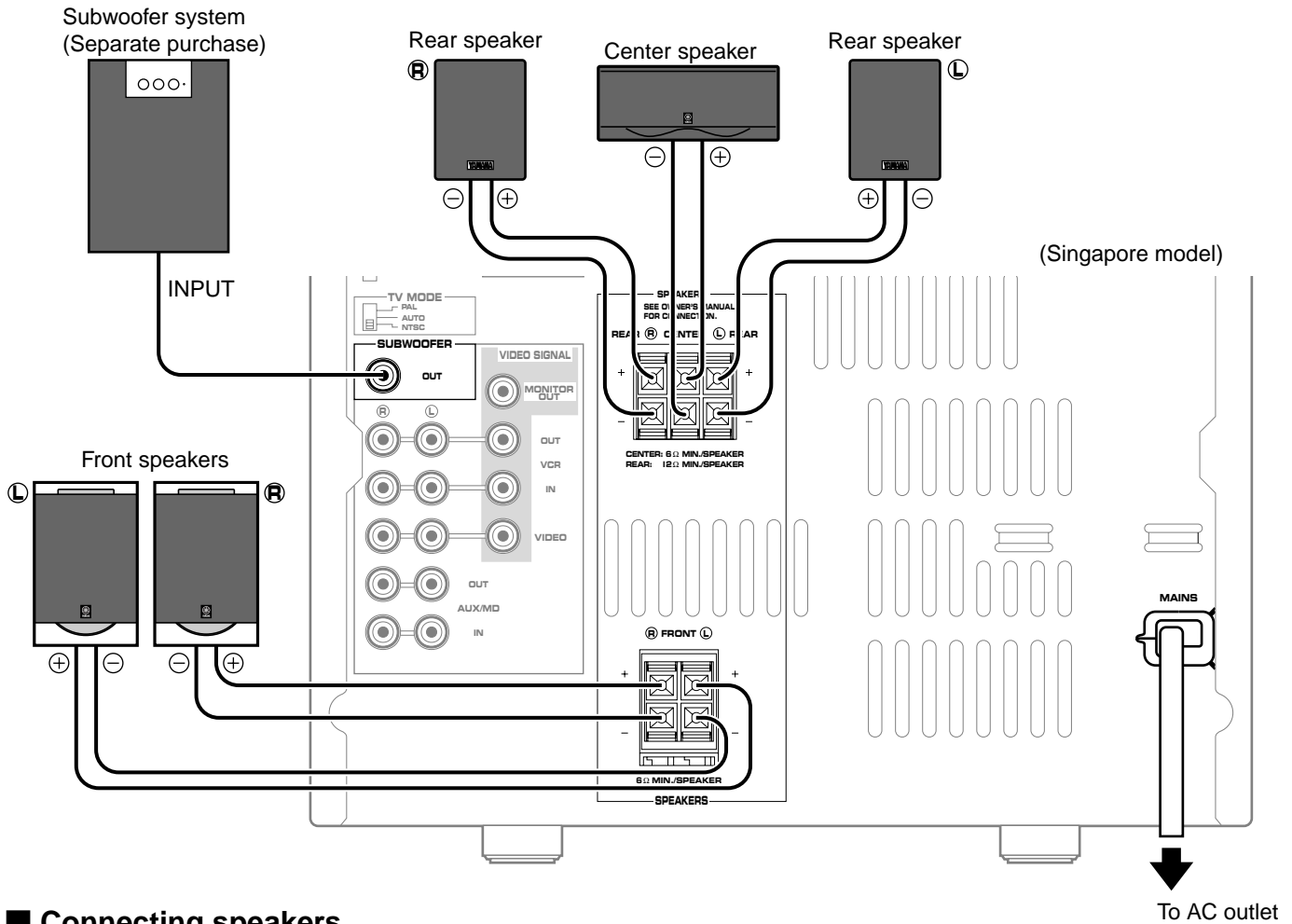

### ■ Connecting speakers

Connect the speakers to the corresponding speaker terminals on the rear of the main unit respectively by using the speaker cords. Make sure that the polarity of the speaker cords is correct, that is the + and – markings are observed. If these cords are reversed, the sound will be unnatural and lack bass.

#### On the speakers

Red: positive (+)  
Black: negative (–)

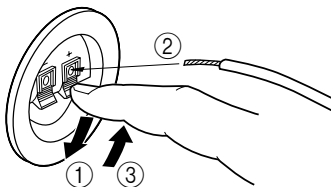

- ① Press the tab
- ② Insert the bare wire.  
[Remove approx. 5mm (1/4") insulation from the speaker wires.]
- ③ Release the tab and secure the wire.

#### On the main unit

Red: positive (+)  
Black: negative (–)

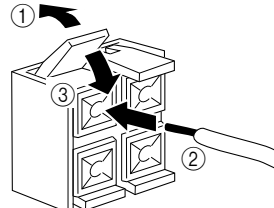

- ① Press up the tab.
- ② Insert the bare wire.  
[Remove approx. 5mm (1/4") insulation from the speaker wires.]
- ③ Press down the tab and secure the wire.

#### Caution

Do not let the bare speaker wires touch each other as this could damage the amplifier and/or speakers.

#### When connecting a subwoofer (separate purchase)

You may wish to add a subwoofer to reinforce the bass frequencies.

When connecting a subwoofer to this system, connect the SUBWOOFER OUT terminal of this system to the INPUT terminal of the subwoofer.

\* Ordinary subwoofers, including the Yamaha Active Servo Processing Subwoofer System, are designed so that the amplifier and subwoofer are in the same unit.

\* The SUBWOOFER OUT terminal outputs low frequencies from the left front, center and right front channels. (The cut-off frequency of this terminal is 200 Hz.)

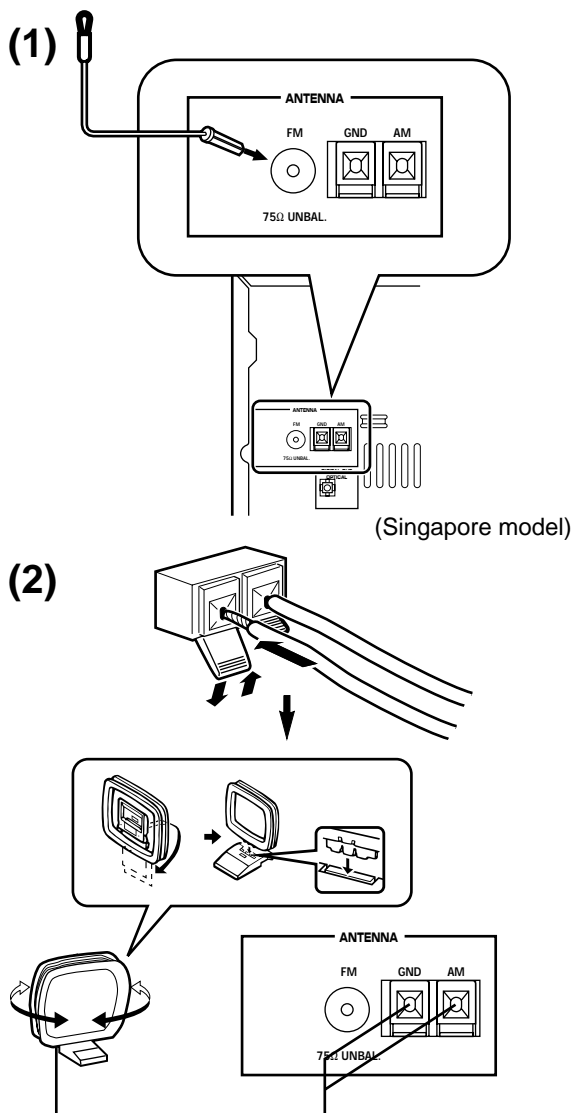

## Antenna connection

### (1) Supplied FM antenna

Connect the FM antenna wire to the corresponding terminal and direct the FM antenna wire to the direction where the strongest signal can be received.

### (2) Supplied AM loop antenna

Connect the AM loop antenna wires to the corresponding terminals. Position the AM loop antenna for optimum reception.

#### Notes

- When static is still heard even after adjusting the position of the AM loop antenna, try reversing the wire connections (from the right terminal to the left one, and vice versa).
- The AM loop antenna should be placed apart from the main unit. The antenna may be hung on a wall.

### Using an external antenna

- Use an external FM antenna instead of an indoor FM antenna if you need better reception. Consult your dealer.
- Use an external AM antenna if you need better reception. Consult your dealer.

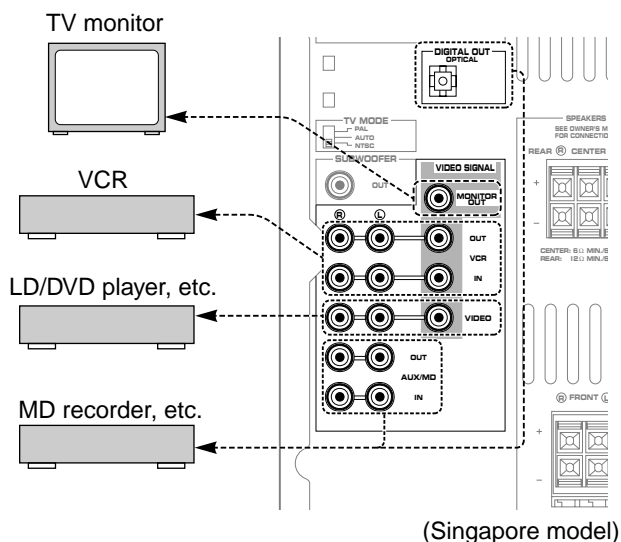

## Connecting external components

### TV monitor

Connect a TV monitor to enjoy playing Video CDs on the built-in CD/Video CD player. Connect a TV monitor to the MONITOR OUT terminal using an RCA pin plug cable.

### External audio and video components

This system can be connected with external audio and video components. Make connections between this system and the components using RCA pin plug connector cables correctly, that is to say L (left) to L and R (right) to R. Also, refer to the owner's manual for the component to be connected to this system.

\* A digital-to-digital recording is possible from a CD played on the built-in CD/Video CD player to an MD (or tape) on an external MD recorder (or DAT) by connecting the DIGITAL OUT (OPTICAL) terminal on the rear of the main unit to the MD recorder (or DAT).



## Setting the clock

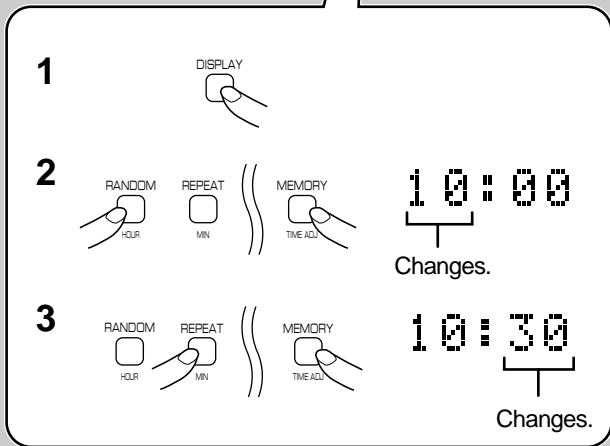
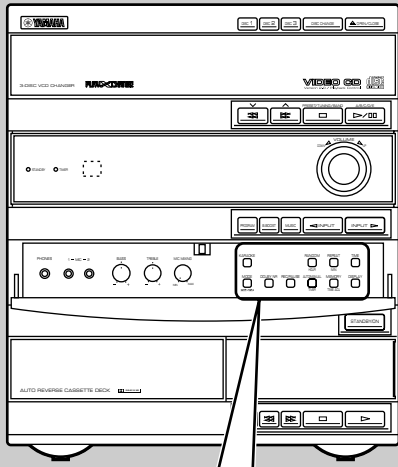

- 1 While the power is on, press **DISPLAY** to display the time.
- 2 While holding **TIME ADJ** pressed, press **HOUR** and set the hour.
  - \* Press **HOUR** once to advance the time by 1 hour. Press and hold to advance continuously.
- 3 While holding **TIME ADJ** pressed, press **MIN** and set the minute.
  - \* Press **MIN** once to advance the time by 1 minute. Press and hold to advance continuously.
  - \* The hour setting will not advance even if minute is advanced from "59" to "00".

Singapore model uses a 24-hour display. For China and General models, either the 24-hour display or the 12-hour display [shown by "AM (PM) 12:00"] is selected depending on the setting of the **FREQUENCY STEP** switch on the rear panel, so you cannot select the desired type freely.

**Note**

In the event of a power failure or when the AC supply lead is disconnected, the time display will go out, however, the clock will function for about 5 minutes without any power supply. Otherwise, the time display will flash on and off to indicate that the time must be reset.

## Adjusting brightness of the display

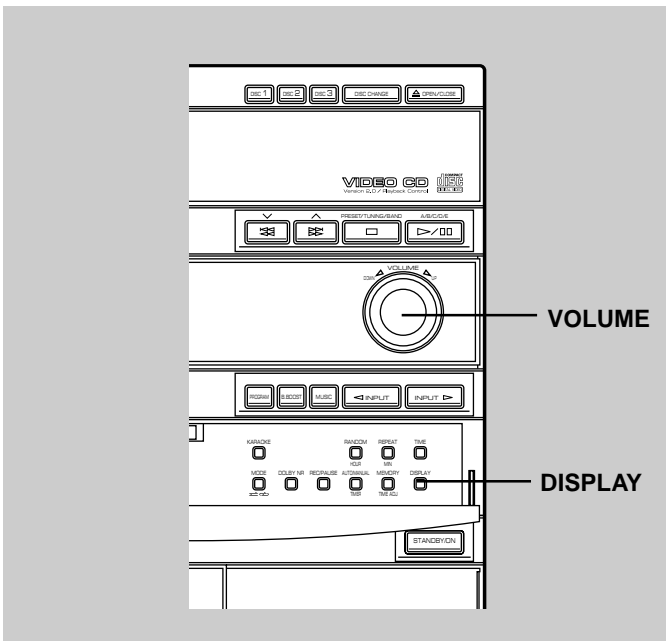

If desired, you can adjust the brightness of the display.

Press and hold **DISPLAY** for more than 2 seconds so that "DIMMER ±0" appears on the display. While holding **DISPLAY** pressed, turn **VOLUME** clockwise to increase or counterclockwise to decrease brightness.

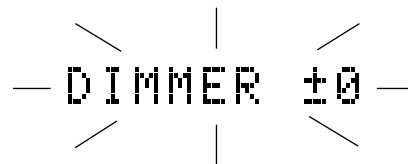

**Control range:** ±0 to -6 (Preset value: ±0)

## Speaker balance adjustment

You can adjust the sound output level balance between the front, center, and rear speakers using the built-in test tone generator. This is important for the best performance of the built-in Dolby Pro Logic surround decoder.

**The adjustment of each speaker output level should be done at your listening position with the remote control. Otherwise, the result may not be satisfactory.**

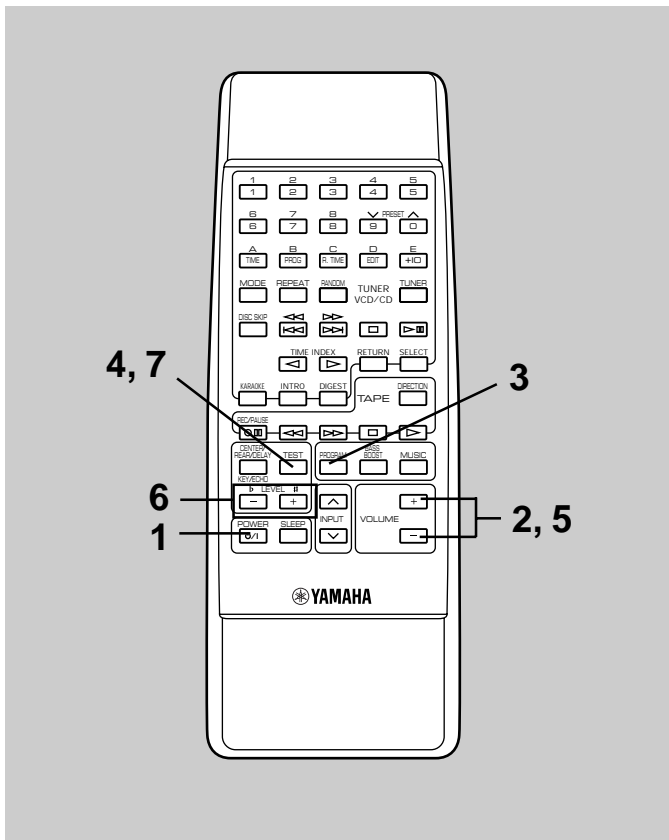

- 1 Turn on the power.
- 2 Turn down the volume to minimum.
- 3 Press **PROGRAM** once or more until "PRO LOGIC" lights up on the sound field program indicator.
- 4 Press **TEST**.  
\* "TEST" flashes on and off on the display.
- 5 Press **VOLUME +** (up) to increase the volume.

You will hear a test tone (like pink noise) from the left front speaker, the center speaker, the right front speaker, and then the rear speakers, for about 2.5 seconds each. The display changes as shown below.

```

LEFT<<<<  ->  >CENTER<
      ^
      |
<SURROUND>  ->  >>>RIGHT
      v
  
```

\* The test tone from the left rear speaker and the right rear speaker will be heard at the same time.

- 6 Press **LEVEL +/-** to adjust the sound output levels of the center speaker and the rear speakers so that the level becomes almost as same as that of the front speakers.

**example)**



- 7 When the adjustments are finished, press **TEST** to cancel the test tone.  
\* "TEST" disappears from the display.

### Note

Once you have completed these adjustments, you can adjust whole sound level on your audio system by using **VOLUME** on the main unit (or the remote control).

## Display information

Each indicator mentioned with a number on pages 12–19 corresponds to the indicator with the same number on this page.

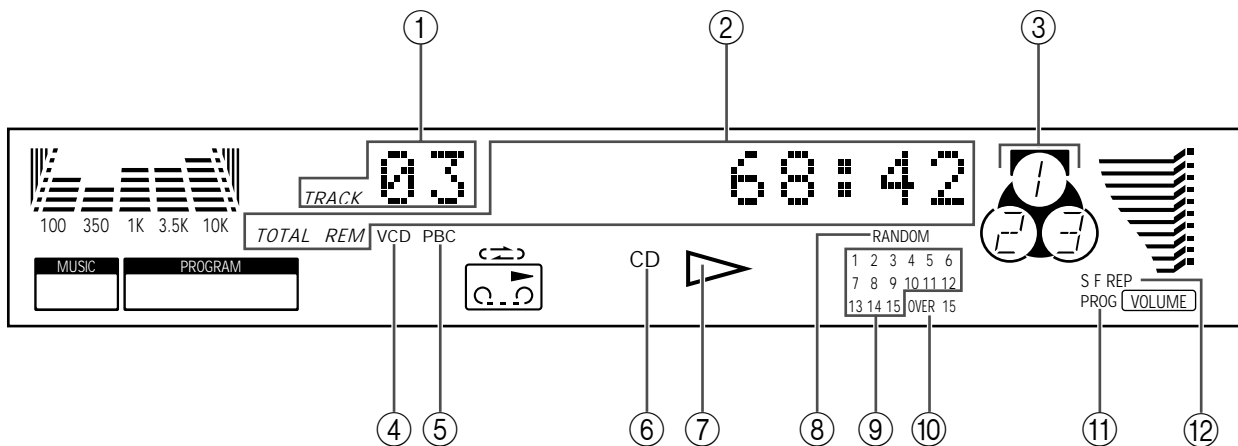

① **TRACK (track number)**

② **Time display**

③ **Disc indicator**

The disc of the number located on the top of this indicator is now being selected.

④ **VCD (Video CD) indicator**

⑤ **PBC (Playback Control) indicator**

⑥ **CD (input source indicator)**

⑦ **▶ (play)**

⑧ **RANDOM**

⑨ **Music calendar**

Track numbers on the currently selected disc will be illuminated (up to the number 15).

⑩ **OVER 15**

This indicator will be illuminated when the currently selected disc has more than 15 tracks.

⑪ **PROG (program)**

⑫ **(S, F) REP [(single, full) repeat]**



## CD/Video CD player operation

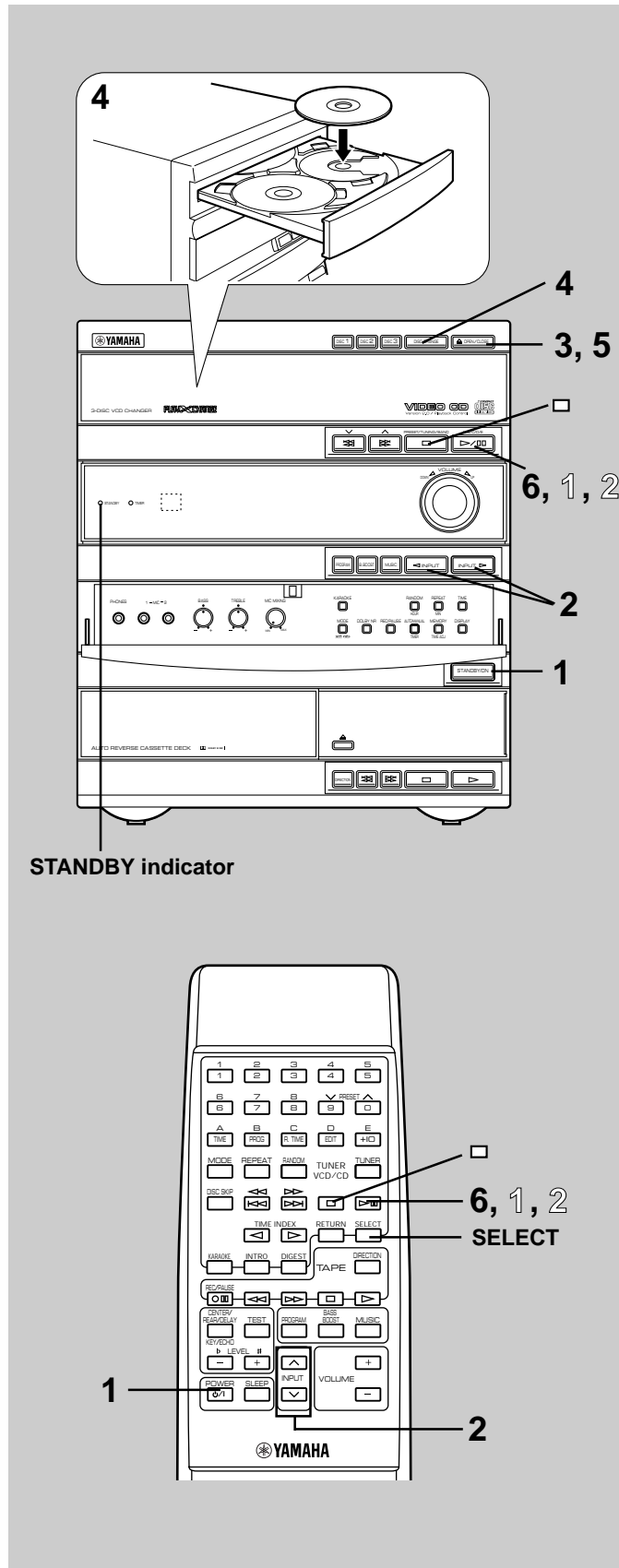

### Direct operation

**DISC** (1, 2 or 3) and **OPEN/CLOSE** on the front panel and **▷/⏸** on the remote control will work if they are pressed when this system is in the standby mode or another input source is selected.

## Basic play

### \* For Video CDs

When you play a Video CD, turn on the TV monitor connected to this system.

- 1 Turn on the power.
- 2 Select the CD/Video CD player by pressing **INPUT** ▷ or ◀ until "VCD/CD" (②) appears on the display.
- 3 Press **OPEN/CLOSE** to open the disc tray.
- 4 Place discs on the table, label side upward.
  - \* Up to three discs can be loaded on the table. To load the third disc, rotate the disc table by pressing **DISC CHANGE** on the front panel.
  - \* 8 cm (3") discs can be played without an adaptor.
  - \* The disc placed on the left side is played first.
- 5 Press **OPEN/CLOSE** to close the disc tray.
  - \* If the selected disc is a CD, the total number of tracks (①) and the total playing time of the disc (②) will be displayed for several seconds.
  - \* If the disc contains more than 15 tracks, the "OVER 15" indicator (⑩) will light up.
  - \* If the disc tray is closed by pushing the front edge of the tray, play will begin automatically.
- \* **For Video CDs**  
If the selected disc is a Video CD, "VCD" (④) lights up on the display.
- 6 Press ▷/⏸ to begin play.

### Note for Video CDs

If a Video CD (version 2.0) is selected, "PBC" (⑤) lights up on the display, yet the total number of tracks (①), the total playing time of the disc (②) and the music calendar (⑨) will not be displayed. In this mode, disc play is controlled by the rule of Playback Control. To play the disc in the Playback Control mode, skip to page 19 and follow the procedure. To cancel this mode and restore the normal play mode, press □. "PBC" (⑤) disappears from the display. To call the Playback Control mode again, press **SELECT** on the remote control.

### To pause

- 1 Press ▷/⏸.
  - \* The "▷" indicator (⑦) will flash.
- 2 Press ▷/⏸ to resume play from the same point.

### To stop play

Press □.

### To finish using this system

Turn this system into the standby mode by pressing **STANDBY/ON**. (The **STANDBY** indicator will light up and the display will go out.)

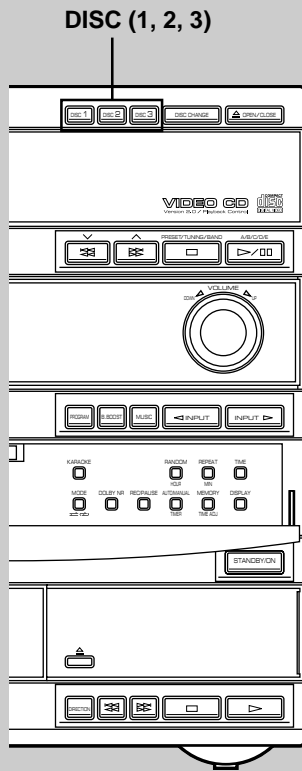

### To change the disc play mode

If necessary, change the disc play mode by pressing **MODE** on the remote control.

**Single disc play mode:** Only the designated disc is played.

**All disc play mode:** All discs on the disc tray are played sequentially.

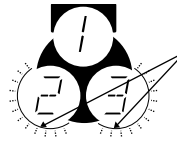

Lights up only when the all disc play mode is selected.

### To select another disc

Press **DISC SKIP** on the remote control once or more (so that the corresponding disc number is located on the top of the disc indicator (③)).

Pressing **DISC (1, 2 or 3)** will select the disc directly, and play will begin from track 1 automatically.

### To select the desired track directly

By using the numeric buttons on the remote control, any track you wish to listen to can be played directly.

Use the numeric buttons to select the desired track number. Play will begin automatically.

**A. For example, to choose track 5**  
Press 5.

**B. For example, to choose track 12**  
(1) Press **+10**.  
(2) Within a few seconds, press 2.

**C. For example, to choose track 20**  
(1) Press **+10**.  
(2) Within a few seconds, press **+10** again.  
(3) Within a few seconds, press 0.

**Note**

If you select a track number higher than the number of tracks on the disc, only the last track of the disc may be played.

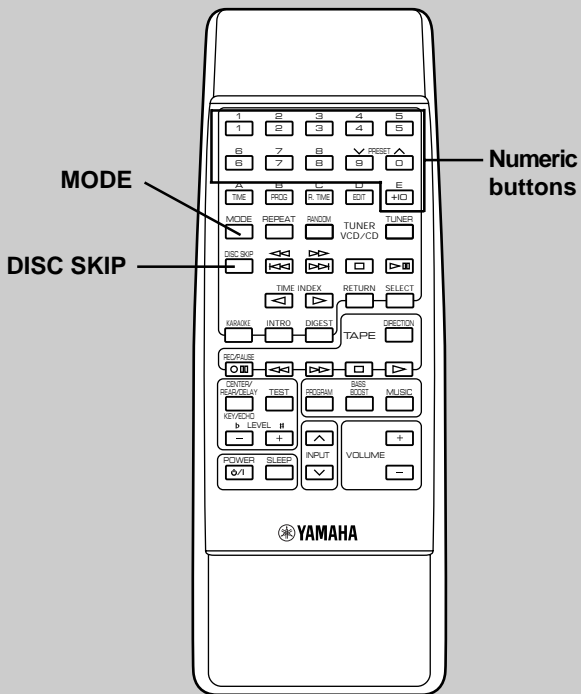



# CD/Video CD player operation

## To play the desired track (Skip)

Press **▷▷** to skip forward or **◁◁** to skip backward. Press once for each track to be skipped.

### Note

This function can also be performed while the CD/Video CD player is stopped. Press **▷/□** when the desired track number appears on the track number display. Play will begin from the beginning of the track.

## To advance or reverse play rapidly (Search)

Press and hold **▷▷** to advance play rapidly, and **◁◁** to reverse play rapidly.

## To exchange a disc (or discs) while playing (PLAYXCHANGE)

During play, you can open the disc tray by pressing **DISC CHANGE** without interrupting play. However, in this case, pressing **DISC SKIP** or **DISC (1, 2 or 3)** is invalid.

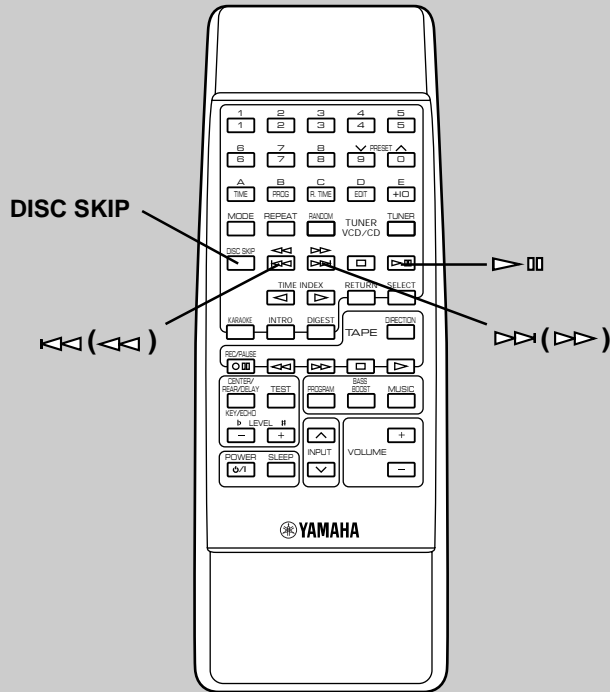
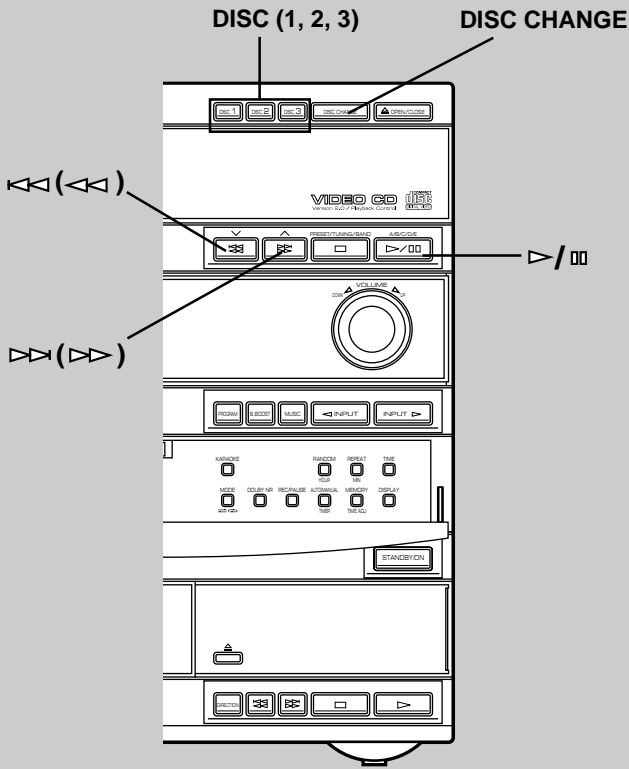



## Program play

You can program up to 20 tracks in any desired order.

- When the CD/Video CD player is stopped, press **PROG** to prepare for programming.
  - \* "PROG" (①) and "P-01" (②) will light up on the display, and all track numbers on the selected disc (⑨) will begin flashing.
- If necessary, select the desired disc by pressing **DISC SKIP**.
  - \* Just after you change the disc, the CD/Video CD player reads the contents of the newly selected disc for a few seconds. During this internal operation, if you go on to the next step, "WAIT" (②) appears on the display and your operation is canceled.
- Use the numeric buttons to select the desired track number.
  - \* The selected track number (①) and the total play time of the programmed tracks (②) will light up on the display, and soon it will be replaced by the display of the next play order (②). Programmed track numbers on the selected disc will stop flashing and light up on the music calendar (⑨).
  - \* Pressing **TIME** displays the total play time of the programmed tracks (②) for about 1 second, and then it is replaced by the display of the next play order (②).
- Repeat steps 2 and 3 to program other tracks.
- Press **▶/⏏** to start the program play.

### Notes

- For Video CDs**
  - When the CD/Video CD player is in the Playback Control mode ("PBC" (⑤) is illuminated on the display) and the play is stopped, pressing **PROG** cancels the Playback Control mode, and so you can make programming operations.
- If the total time of the programmed tracks becomes 100 minutes or more, the highest position of the figure will not be displayed.
- The total time of the programmed tracks will not be displayed, if track number 16 or higher is programmed.
- Skip (◀◀/▶▶) can be performed during play, but only within the range of the programmed tracks.
- Search can be performed during play to search all tracks, including unprogrammed tracks.

### To cancel a programmed sequence

There are several methods as described below.

- Press **⏏** while the CD/Video CD player is stopped.
- Open the disc tray.
- Turn this system into the standby mode.

### To check (and correct) program data

- Press **PROG** when the CD/Video CD player is stopped.
- Every time **▶▶** is pressed, the track numbers and sequential order of the programmed tracks can be checked one after another. The display of the track number can be returned (sequentially in reverse order) by pressing **◀◀**.
- If you want to correct the program data, press a numeric button to select the track to replace the one displayed. The previously programmed track will be cleared from the memory and the new one will be programmed. To complete the correction, press **PROG** or **▶/⏏** once again.

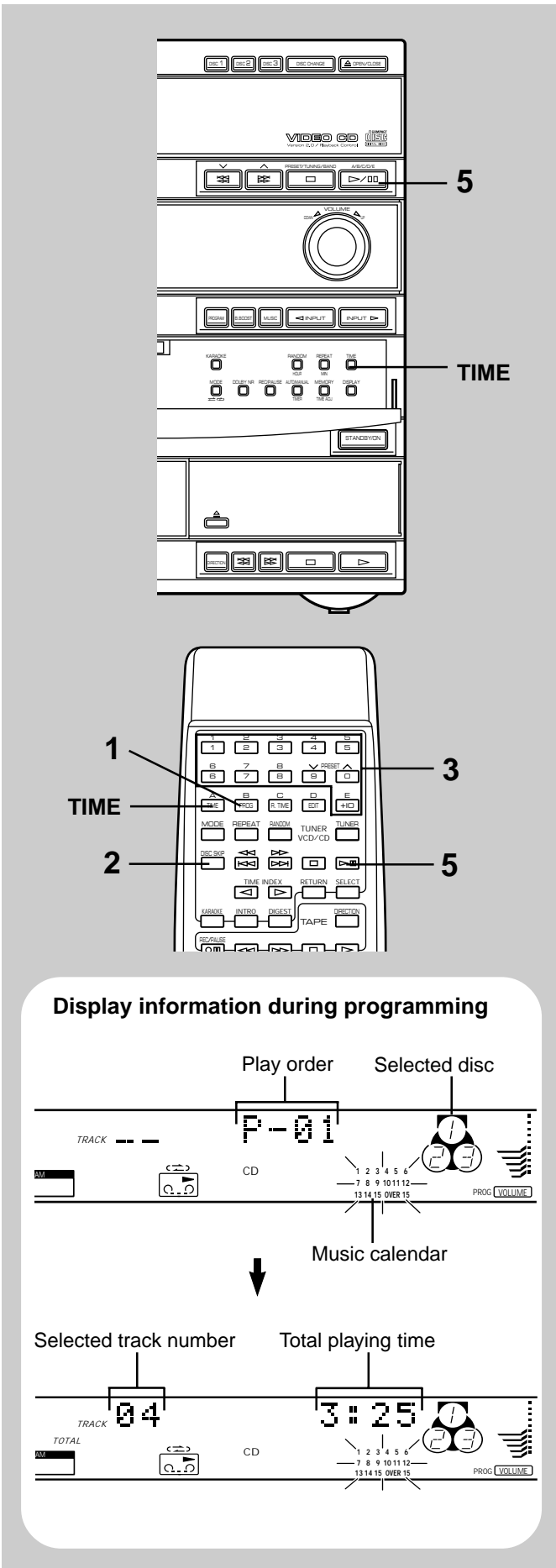

### Display information during programming

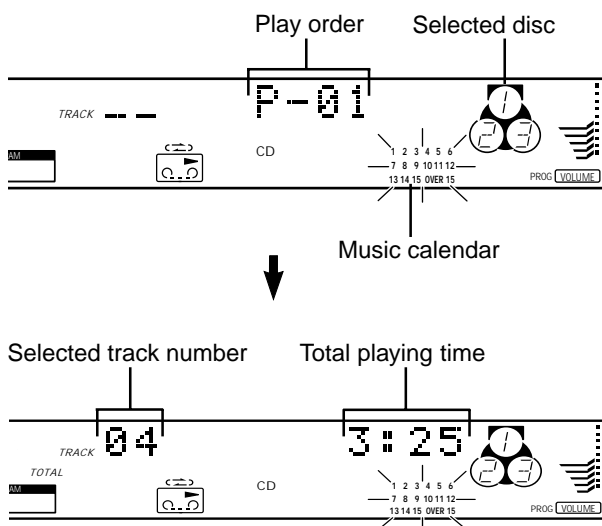



## CD/Video CD player operation

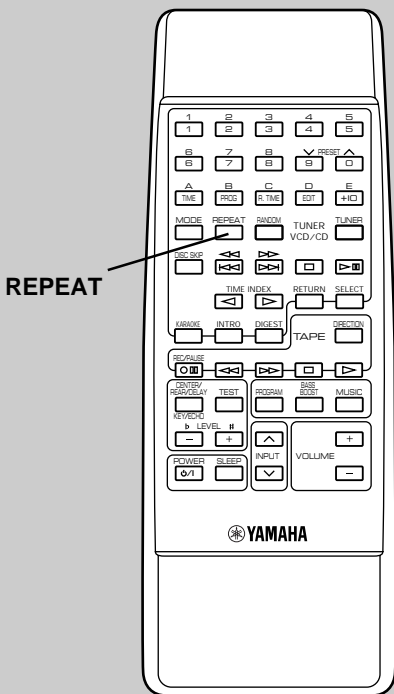
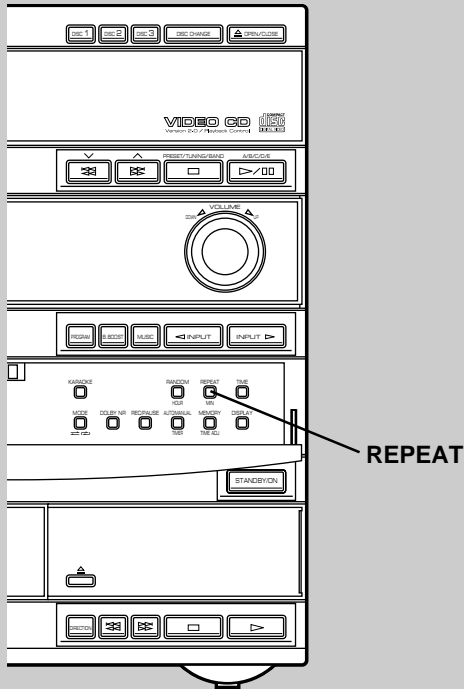

### Repeat play

All discs, a disc, a single track or a programmed sequence can be continuously repeated.

Press **REPEAT** once or more to select the desired repeat play mode so that the S REP or F REP indicator (12) is illuminated.

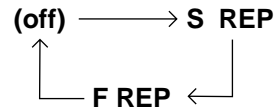

### Repeat play modes

#### SINGLE REPEAT (S REP)

A single track is played repeatedly.

\* This is also available in the program play mode and the random play mode. (If the repeat play mode is switched off, the program play mode or the random play mode will be resumed.)

#### FULL REPEAT (F REP)

When the CD/Video CD player is in the single disc play mode:

The designated disc is played repeatedly.

\* In the random play mode, the selected disc is repeatedly played, but the order of tracks is different every time.

When the CD/Video CD player is in the all disc play mode:

All discs on the disc tray are played repeatedly.

\* In the random play mode, the random play is performed among all discs and repeated with a different order of tracks every time.

#### Notes

- In the program play mode, a sequence of programmed tracks is played repeatedly.
- **For Video CDs**  
When the CD/Video CD player is in the Playback Control mode ("PBC" (5) is illuminated on the display), no repeat play mode can be selected.

#### To cancel the repeat play

Press **REPEAT** once or more so that the (S, F) REP indicator (12) goes out.





### Random play

Tracks on a selected disc or all discs on the disc tray can be played randomly.

**1** If necessary, switch the disc play mode by pressing **MODE**.

\* If the single disc play mode is selected, select the desired disc by pressing **DISC SKIP**.

**2** Press **RANDOM** to begin random play.

\* The "RANDOM" indicator (⑧) will light up.

#### To cancel the random play

Press **□**, or press **RANDOM** so that the "RANDOM" indicator (⑧) will go out.

#### Notes

- This feature will not function during programming or program play.
- **For Video CDs**  
**RANDOM** can work when the CD/Video CD player is in the Playback Control mode and stopped. In this state, pressing **RANDOM** cancels the Playback Control mode.

### Switching the time display

Every time **TIME** is pressed, the display will change as described below.

#### [Example]

When the second track is being played.

The elapsed play time for the current track will be displayed.

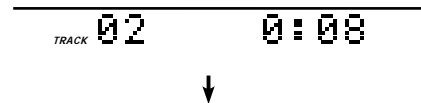

The remaining play time for the current track will be displayed.



The total play time of the disc will be displayed.

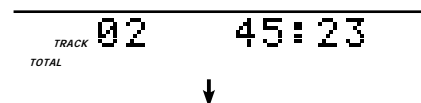

The total remaining play time of the disc will be displayed.

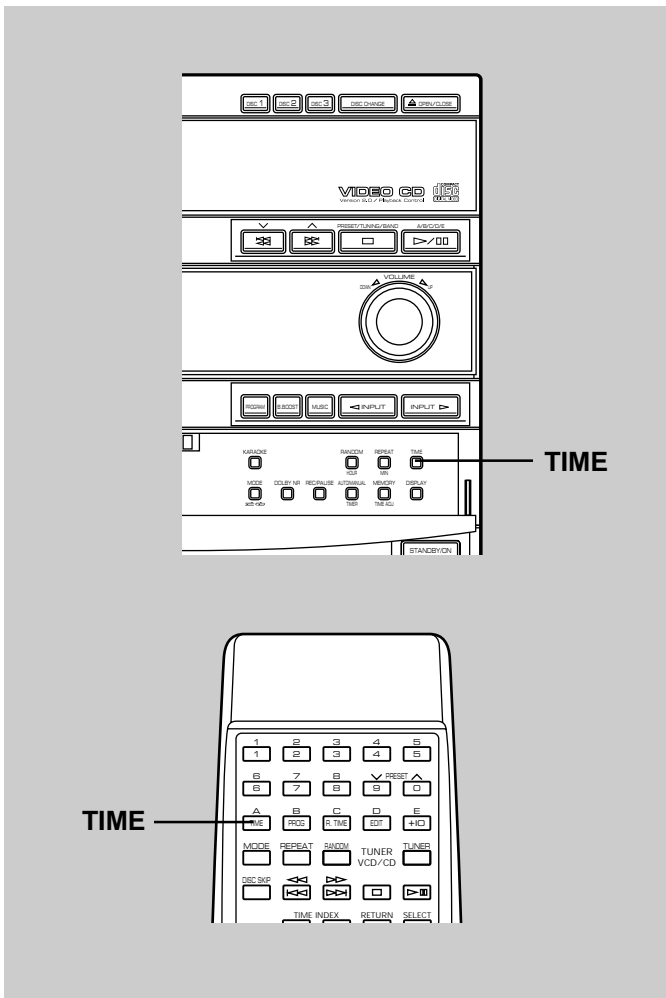
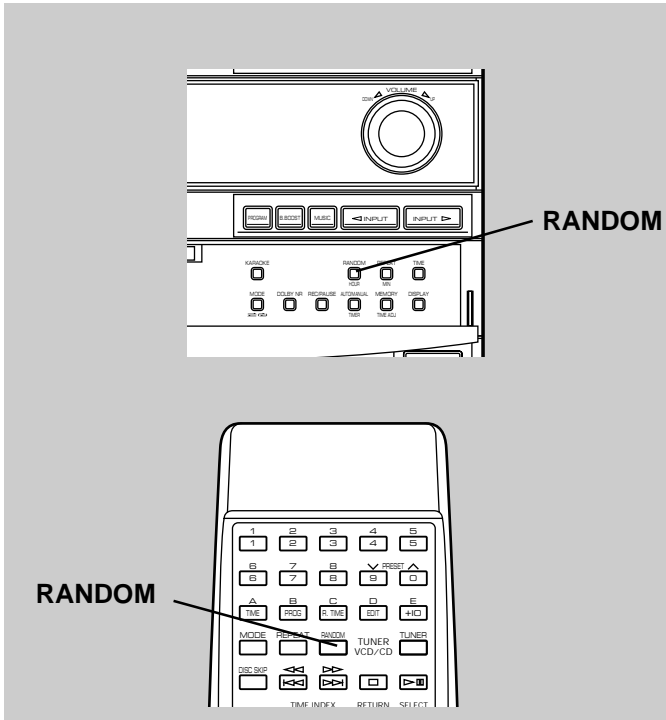
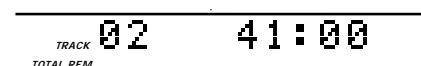



## CD/Video CD player operation

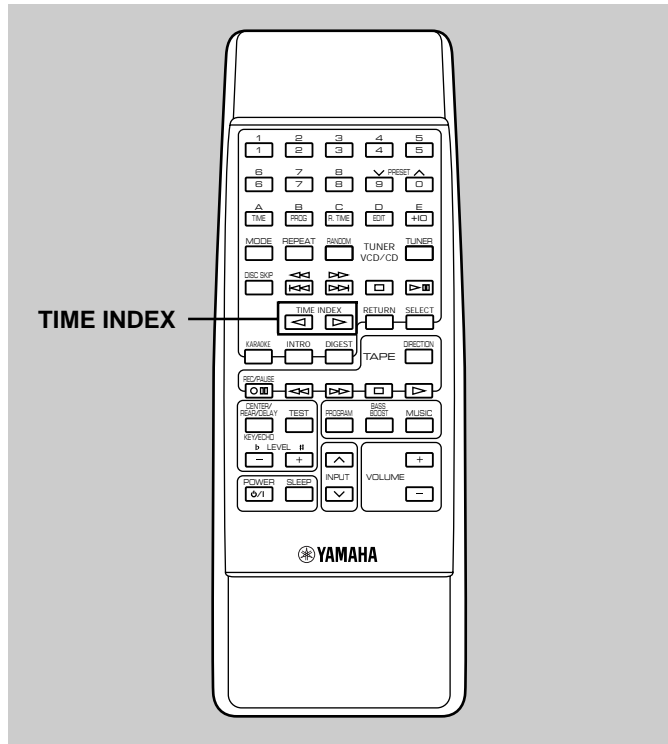

### To find your desired scene quickly for Video CDs

Press **TIME INDEX** ◀ or ▶ once or more to skip forward or backward by the displayed time.

By pressing a button repeatedly, the time on the display and TV monitor changes.

#### Notes

- While playing a disc, you can skip forward or backward through the entire disc.
- While playing a Video CD (version 2.0) in the Playback Control mode, you can skip forward or backward through the selected track.

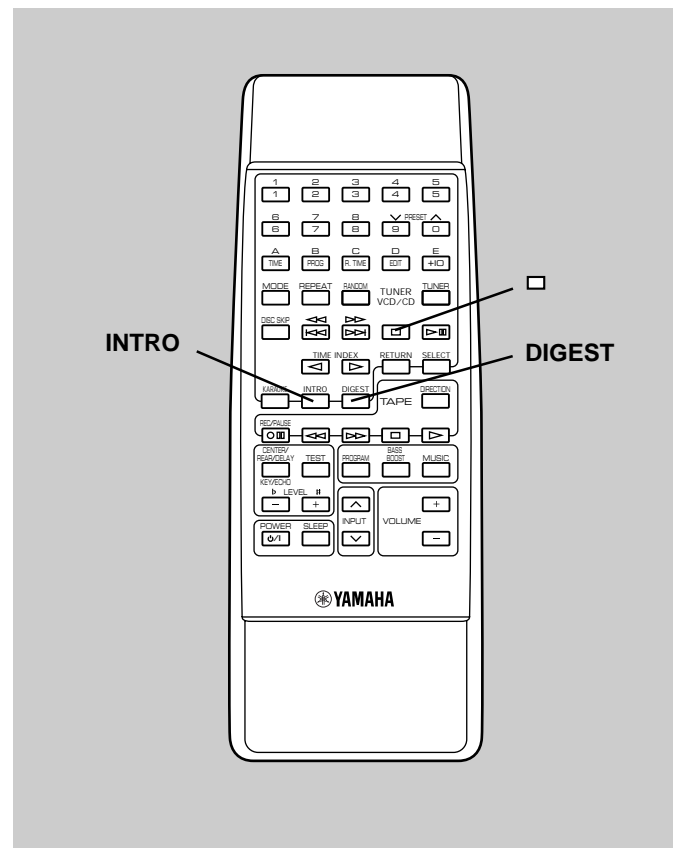

### To get a quick overview of a track or a disc for Video CDs

Press **DIGEST** to see the scenes of a selected track on a Video CD.

Press **INTRO** to see the beginning of all tracks on a Video CD.

You can watch up to nine screens at a time on the TV monitor. You can begin play from the desired scene by pressing a numeric button (1 to 9) which corresponds to the number of the scene.

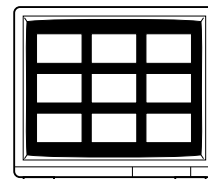

#### Notes

- These buttons cannot work when playing a Video CD (version 2.0) in the Playback Control mode. To make these buttons work, press □ to stop playing.
- These **DIGEST** and **INTRO** operations repeat endlessly until you stop play.
- These button cannot work in the program play and random play modes.
- The monitor can show up to nine screens at a time. The number of screens varies from disc to disc. There may be a case that the monitor shows only one screen as shown below.

### To cancel DIGEST and INTRO operations

Press □.

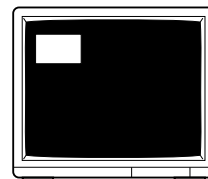



# Playback Control of Video CD (version 2.0) for Video CDs

This function is available for a Video CD (version 2.0) only. "PBC" will light up on the display when a version 2.0 disc is used. The Playback Control differs with each disc. Refer to the instructions of the disc for details.

You can enjoy the following functions.

### Selection on a screen menu

You can select pictures, music and information to play by selecting items on a screen menu.

### High quality pictures (for discs including still pictures)

You can enjoy still pictures which are four times as high in quality as moving pictures.

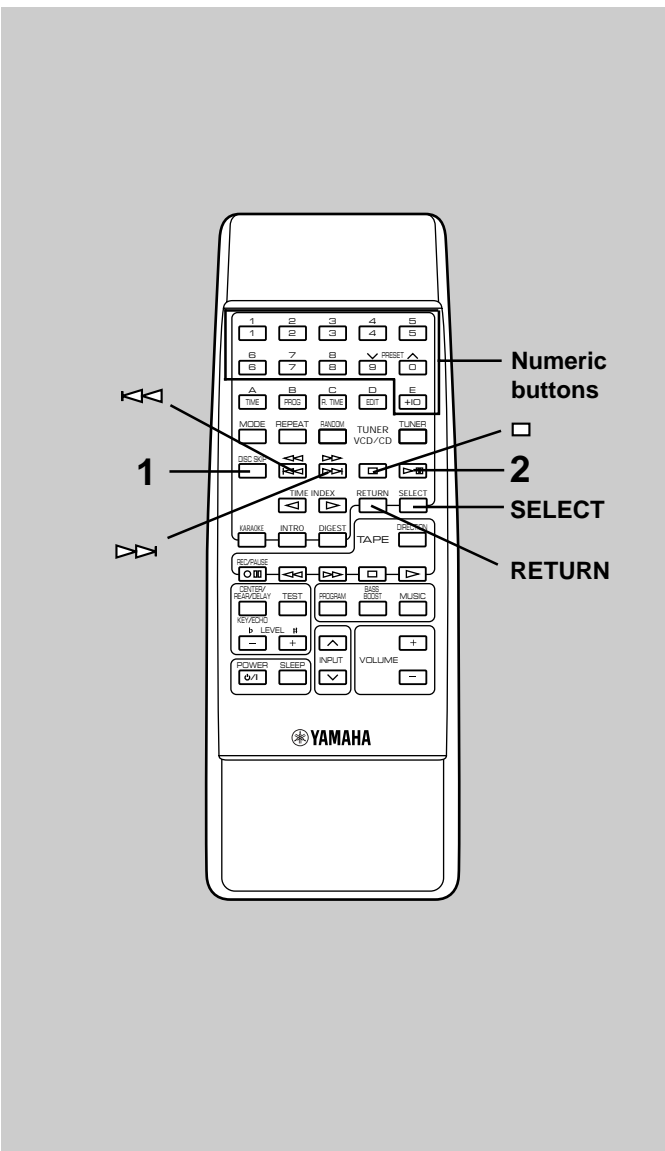

## Basic operation

Use the remote control for making Playback Control operations.

### Note

Disc play in the Playback Control mode depends on the data of the disc used. The operations and buttons to be used may vary for each disc.

- 1 Select a Video CD (version 2.0) by pressing **DISC SKIP** on the remote control.  
\* "PBC" (5) lights up on the display.
- 2 Press **▶▶**.  
\* A screen menu, a series of short movies, or the like appears on the TV monitor. It differs with each disc.
- 3 In the Playback Control mode, the following buttons on the remote control can be used.  
However, the usable buttons and their functions differ with each disc.

**SELECT:** Used to select the desired movie when short movies are sequentially played instead of a menu

**RETURN:** Used to return to the previous screen menu or picture

**▶▶:** ● Used to advance to the next menu or picture when "▶▶" or "NEXT" is displayed on the TV monitor.  
● Used to change play direction from reverse to advance.

**◀◀:** ● Used to return to the previous menu or picture when "◀◀" or "PREV" is displayed on the TV monitor.  
● Used to change play direction from advance to reverse.

**Numeric buttons:** Used to select the desired item on a screen menu.

### Notes

- In the Playback Control mode, **TIME** and **REPEAT** will not work.
- **PROG**, **RANDOM**, **DIGEST** and **INTRO** can work when the CD/Video CD player is in the Playback Control mode and stopped. In this state, pressing one of these buttons cancels the Playback Control mode.

### To return to the previous screen mode during play

Press **RETURN** once.

\* To return to the first screen mode, press **RETURN** repeatedly until the first screen mode appears.

### To stop play

Press **□**.

### To play a Video CD (version 2.0) without Playback Control operation

Press **□** while the CD/Video CD player is stopped. "PBC" (5) disappears from the display, and the normal play mode is restored.

To restore the Playback Control mode again, press **SELECT**.

# Tuning operation

## Display information

Each indicator mentioned with a number on pages 21–23 corresponds to the indicator with the same number on this page.

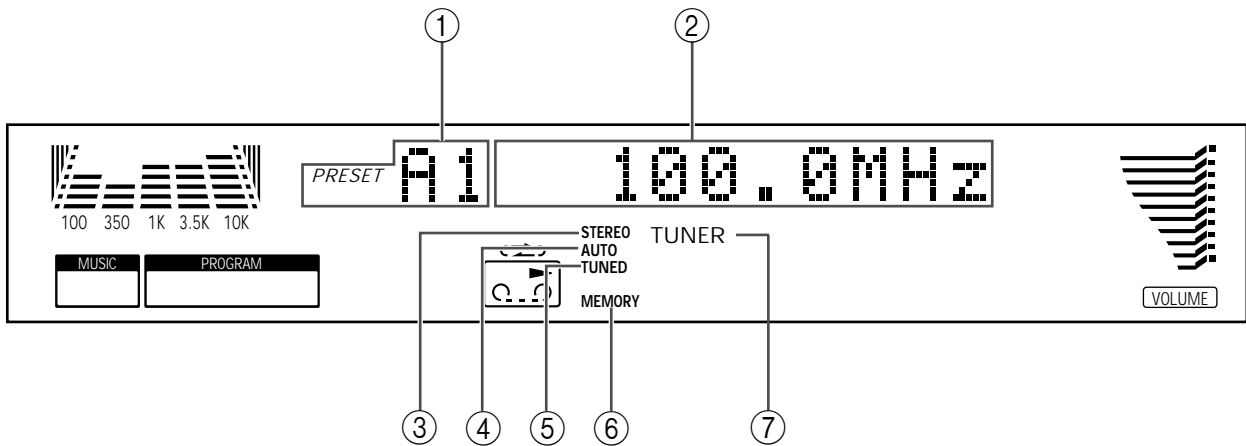

① Preset station group and number indicator

② Multi-information display

③ STEREO

④ AUTO

⑤ TUNED

⑥ MEMORY

⑦ TUNER (input source indicator)



## Automatic tuning

- 1 Turn on the power.
- 2 Press **INPUT**  $\triangleright$  or  $\triangleleft$  until "TUNER" (②, ⑦) appears on the display, or simply press **TUNER** on the remote control.
- 3 Select the reception band (FM or AM) by pressing **PRESET/TUNING/BAND** confirming it on the display (②).
  - \* Do not select the preset tuning mode (in which "PRESET" (①) lights up on the display).
- 4 Press **AUTO/MANUAL** so that "AUTO" (④) lights up on the display.
- 5 Press  $\wedge$  to tune to a higher frequency, or press  $\vee$  to tune to a lower frequency.  
(When tuned in to a station, "TUNED" (⑤) will light up on the display.)
- 6 If the station where tuning search stopped is not the desired one, follow step 5 again.
  - \* If the tuning search does not stop at the desired station, change to the Manual tuning method as described below.
  - \* "STEREO" (③) will light up when an FM stereo broadcast with sufficient signal strength is received.

## Direct operation

**TUNER** on the remote control will work if it is pressed when this system is in the standby mode or another input source is selected.

## Manual tuning

- 1 Follow steps 1 to 3 of the Automatic tuning method.
- 2 Press **AUTO/MANUAL** so that "AUTO" (④) disappears from the display.
- 3 Press and hold  $\wedge$  to tune to a higher frequency, or press and hold  $\vee$  to tune to a lower frequency. Release it just before reaching the desired frequency, and then press it repeatedly until the desired frequency appears.  
(When tuned in to a station, "TUNED" (⑤) will light up on the display.)

## Note

If you tune in to an FM station manually, it is received in monaural to increase the signal quality.

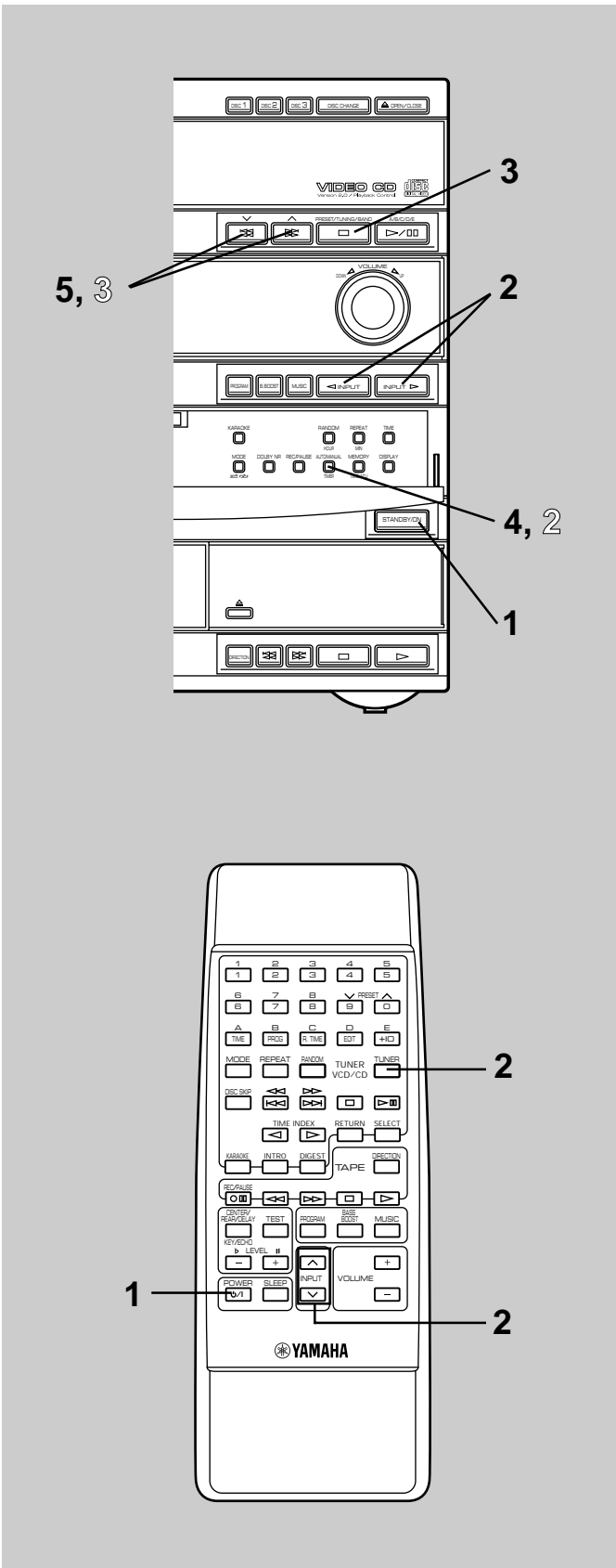



## Tuning operation

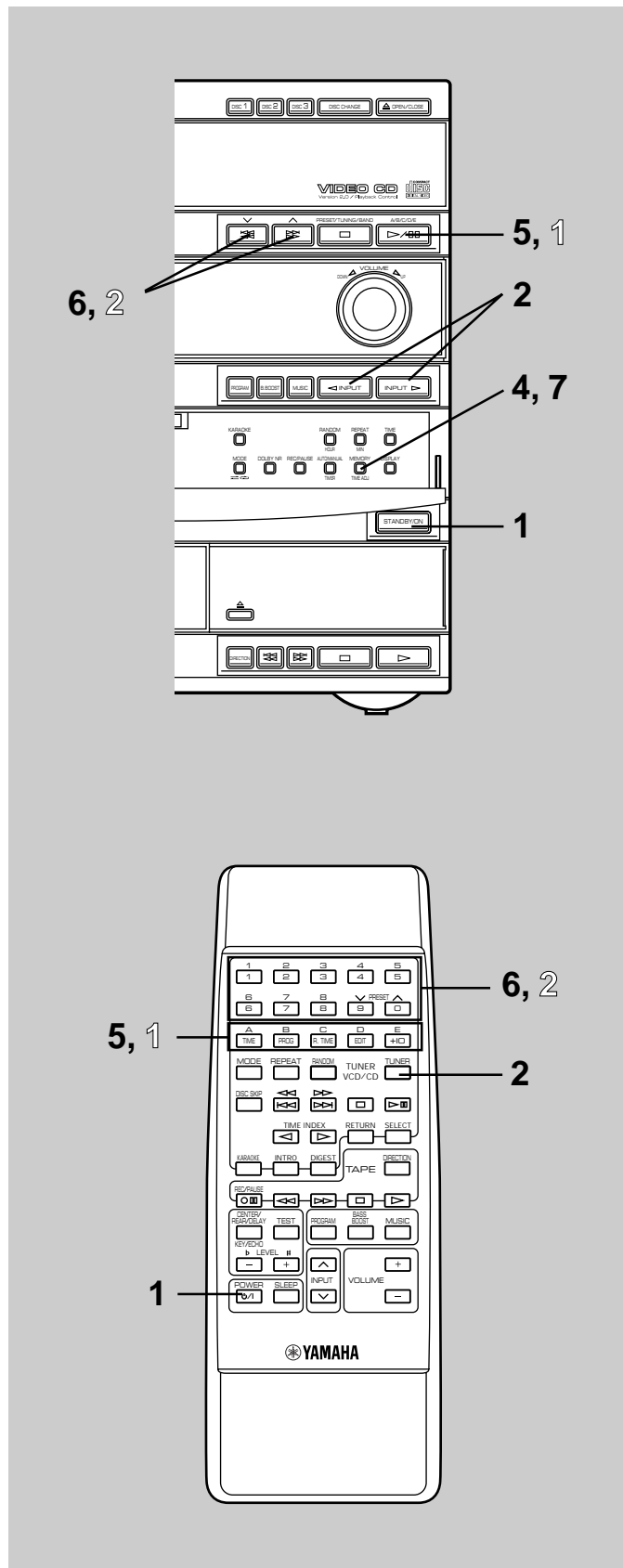

### Manual preset tuning

The built-in tuner can store station frequencies selected by tuning operation. With this function, you can select any desired station only by calling the corresponding preset station number. Up to 40 stations (8 stations x 5 groups) can be stored.

#### ■ To store stations

- 1 Turn on the power.
- 2 Press **INPUT**  $\triangleright$  or  $\triangleleft$  until "TUNER" (②, ⑦) appears on the display, or simply press **TUNER** on the remote control.
- 3 Turn in to the desired station.
- 4 Press **MEMORY**.
  - \* "MEMORY" (⑥) and "PRESET" (①) will flash on the display for about 5 seconds.
- 5 Select the desired group (A – E) of preset stations by pressing **A/B/C/D/E** confirming it on the display, before "MEMORY" (⑥) goes out.
- 6 Select a preset station number by pressing  $\vee$  or  $\wedge$  repeatedly or pressing a numeric button (1 to 8) before "MEMORY" (⑥) goes out.
- 7 Within about 5 seconds, press **MEMORY** again.

#### ■ To recall a preset station

- 1 Select a group of preset stations by pressing **A/B/C/D/E**.
- 2 Select the desired preset station number by pressing  $\vee$  or  $\wedge$  repeatedly or pressing a numeric button (1 to 8).

#### Notes

- A new setting can be programmed in place of the former one.
- For presets the setting of **AUTO/MANUAL** is stored along with the station frequency.

## Automatic preset tuning

You can make use of an automatic preset tuning function. With this function, the built-in tuner performs automatic tuning. Up to 40 stations are stored automatically.

- 1** Turn on the power.
- 2** Press **INPUT**  $\triangleright$  or  $\triangleleft$  until "TUNER" (②, ⑦) appears on the display, or simply press **TUNER** on the remote control.
- 3** Press and hold **MEMORY** for more than 2 seconds.  
\* The "MEMORY" (⑥) and "AUTO" (④) indicators flash.

The tuner performs automatic tuning and searches FM and AM stations in that order. Received stations are programmed to A1, A2 ... A8 sequentially.

### When the automatic preset tuning is completed;

The display shows the frequencies of the first preset station (stored to A1).

If you want to check the contents and the number of preset stations, follow the procedure of the section "To recall a preset station" on the previous page.

### To recall a preset station

Simply follow the procedure of the section "To recall a preset station" on the previous page.

### Notes

- The automatic preset tuning search will be performed through all frequencies until 40 stations are stored. If the number of received stations is less than 40, the search will stop after searching all frequencies.  
\* Since FM stations are searched for first, there may be a case that 40 preset stations are occupied by FM stations only.
- With this function, only stations with sufficient signal strength are stored automatically. If the station you want to program is weak in signal strength, tune in to it with the Manual tuning method (in monaural) and program it by following the procedure of the section "To store stations" on the previous page.
- You can replace a preset station with another FM or AM station manually by simply following the procedure of the section "To store stations" on the previous page.

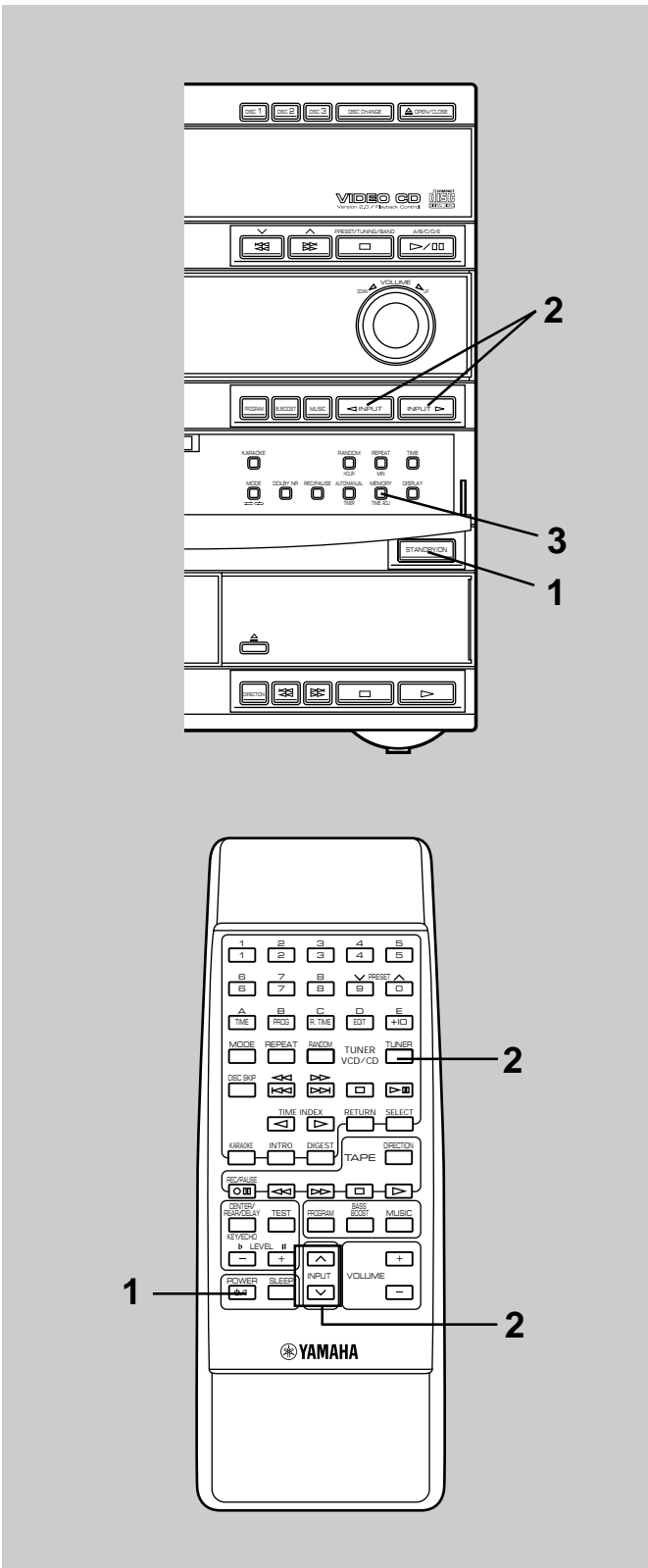

### Memory back-up

The memory back-up circuit prevents the programmed data from being lost even if the AC supply lead is disconnected from the AC outlet or the power is cut due to temporary power failure. If, however, the power is cut for more than one week, the memory may be erased. If so, it can be re-programmed by simply following the Preset tuning steps.

# Playing back a tape

## Display information

Each indicator mentioned with a number on pages 25–30 corresponds to the indicator with the same number on this page.

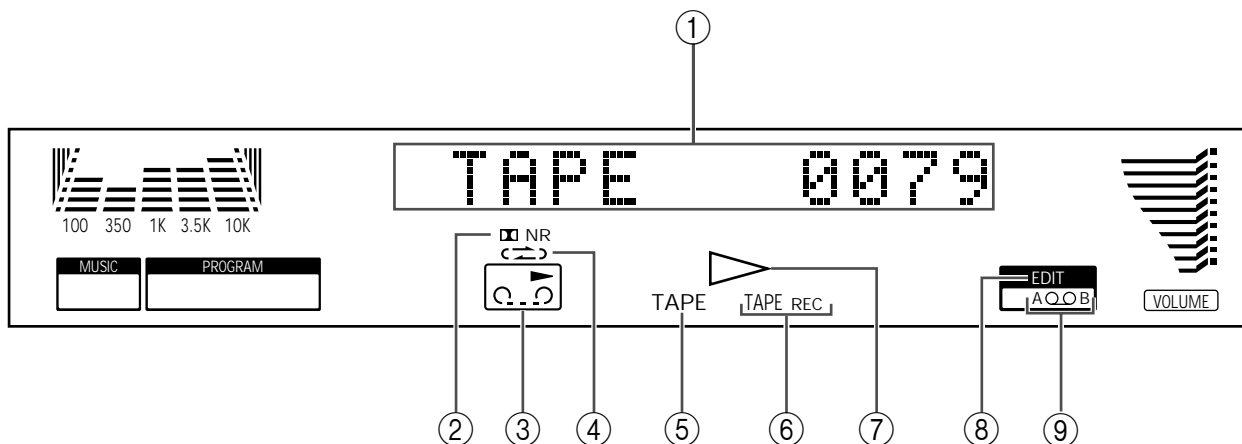

- |                            |                                 |                       |
|----------------------------|---------------------------------|-----------------------|
| ① Tape counter             | ④ Reverse mode indicator        | ⑦ ▷ (play)            |
| ②  NR (DOLBY NR)           | ⑤ TAPE (input source indicator) | ⑧ EDIT                |
| ③ Tape direction indicator | ⑥ TAPE REC                      | ⑨ Tape side indicator |

## General information

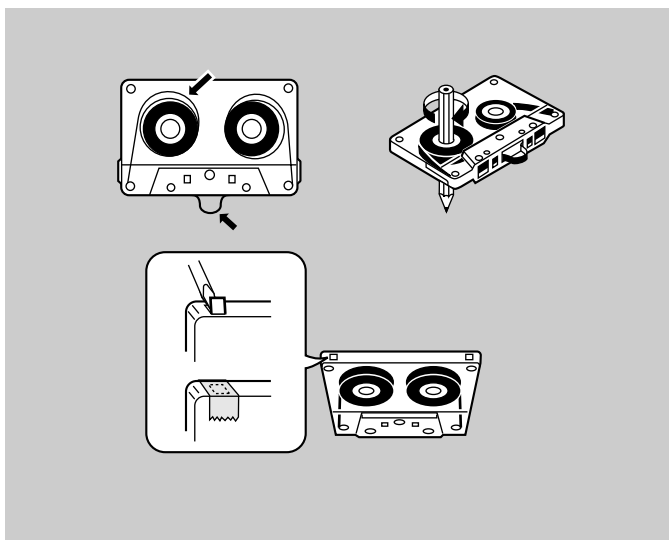

- Do not use C-120 tapes or poor-quality tapes, since they can cause malfunctions.
- Before loading a tape on the tray, tighten the tape slack with a pen or pencil.
- Tapes have removable tabs which prevent accidental recording or erasing from taking place. Removing the tab on the top left protects the side facing you from erasure. Cover the tab holes with adhesive tape to erase or record again.
- The tape deck features an automatic tape selector. Just load the tape, and the tape formula being used will be sensed automatically.
- The tape deck can play back metal tapes as well as normal or chrome tapes, however recording cannot be done on metal tapes with good sound quality.

### Dolby B Type Noise Reduction

Dolby noise reduction is an extremely effective method of reducing undesirable background hiss on tapes. The built-in tape deck incorporates Dolby B type noise reduction system. **DOLBY NR** is useful to both recording and playback; be sure that the same noise reduction is used on recording and playback.

Dolby noise reduction manufactured under license from Dolby Laboratories Licensing Corporation. "DOLBY" and the double-D symbol are trademarks of Dolby Laboratories Licensing Corporation.

### About the tape counter

The tape deck is equipped with a tape counter that is useful for searching and locating a desired point on the tape. The tape counter is shown on the display. Pressing (stop) when the deck is stopped will reset the tape counter to "0000".







# Playing back a tape

## Basic operation

- 1 Turn on the power.
- 2 Press **INPUT**  $\triangleright$  or  $\triangleleft$  until "TAPE" (①, ⑤) appears on the display.
- 3 Open the tray by pressing  $\triangle$ .
- 4 Load the tape on the tray with side A upward, and close the tray by pressing  $\triangle$  or pushing the front edge of the tray gently.
- 5 Press **MODE** or **DIRECTION** to change the current setting if necessary.

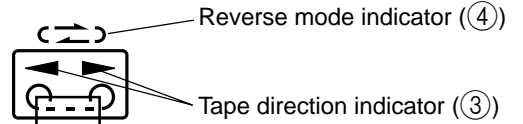
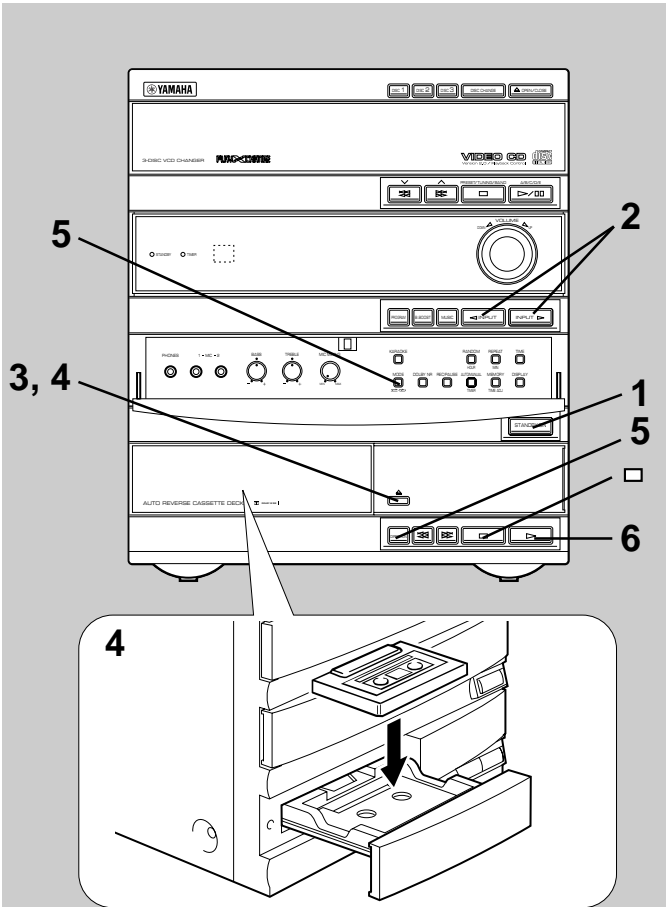

Moves slowly in the current tape running direction during playback.

MODE	$\rightarrow$	$\rightarrow \curvearrowright$	$\curvearrowright \rightarrow$
DIRECTION	Side A only	Side A $\rightarrow$ Side B	Side A $\rightarrow$ Side B (Repeats 8 times) Starts from side A.
	Side B only	Side B only	Side B $\rightarrow$ Side A (Repeats 8 times) Starts from side B. (Side A is not played at the first time.)

- 6 Press  $\triangleright$ .  
Playback begins.

**To stop playback**  
Press  $\square$ .

**To remove the tape**  
Open the tray by pressing  $\triangle$ .

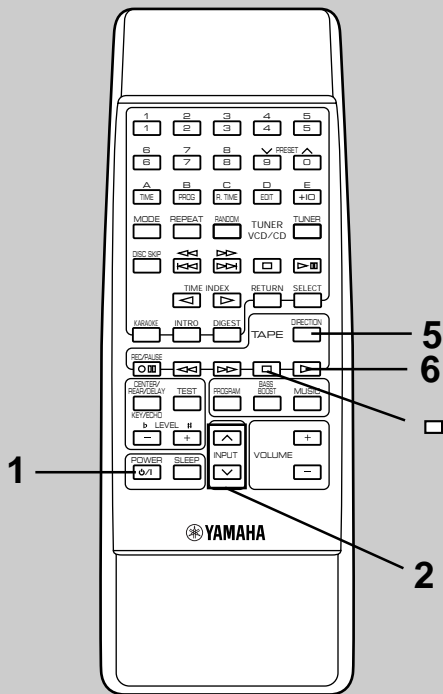

### Direct operation

$\triangleright$  and  $\triangle$  will work if they are pressed when this system is in the standby mode or another input source is selected.



## Playing back a tape

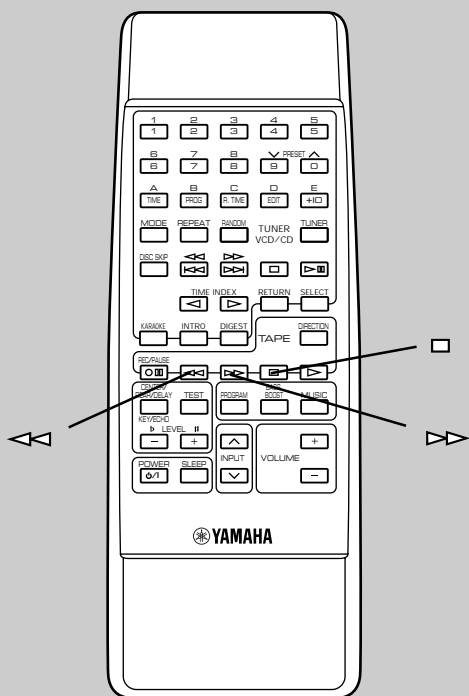
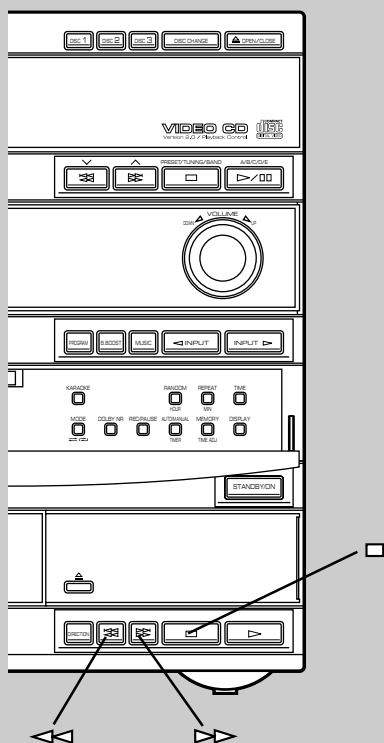

## Winding the tape

1 Press ◀◀ or ▶▶ to wind the tape.

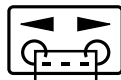

Moves rapidly in the current tape running direction while winding.

2 Press □ to stop.

### Note

When the tape is wound to the end, the tape deck will then function as described below.

- ▶▶ : The tape stops at the end.
- ▶▶▶ : If the winding direction is ▶, when the tape reaches the end, playback automatically starts from the reverse side.  
If the winding direction is ◀, the tape stops at the end.
- ◀▶▶ : When the tape reaches the end, playback automatically starts from the reverse side.

## Searching for the beginning of the desired selection

Press ◀◀ or ▶▶ during playback.

### To listen to the same selection

Press ◀◀ if the direction of the current playback is ▶.  
Press ▶▶ if the direction of the current playback is ◀.

### To listen to the next selection

Press ▶▶ if the direction of the current playback is ▶.  
Press ◀◀ if the direction of the current playback is ◀.

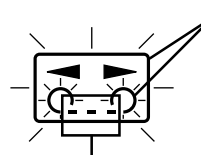

Flashes on and off.

Moves rapidly in the current tape running direction while searching.

### Notes

- This function may not work for tapes with
  - \* Material with long pauses or quiet passages.
  - \* Low recording levels or excessive noise.
  - \* Pauses of less than 4 seconds between selections.
- If searching is carried out at the first or the last part of a selection, the desired selection may not be found.

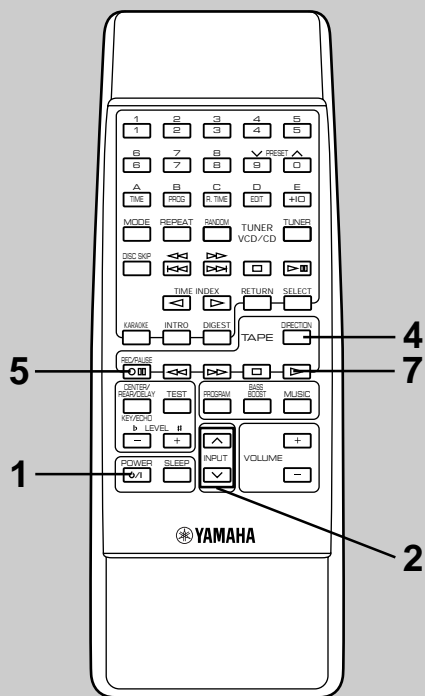
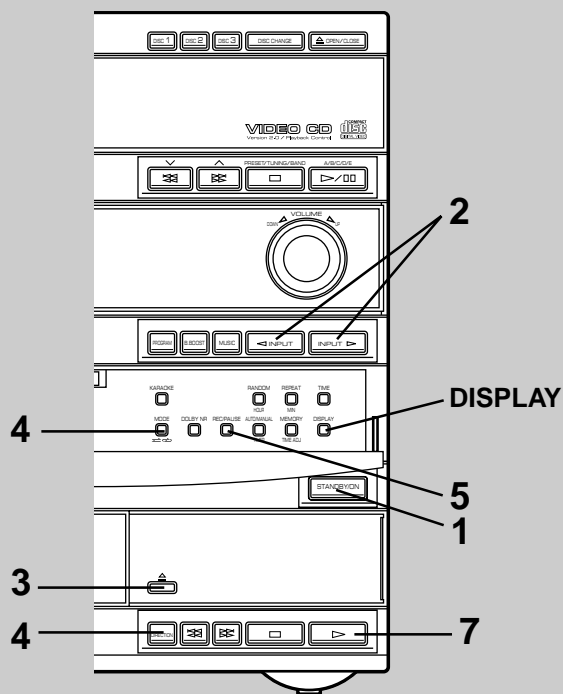



### Notes

- Adjusting the **VOLUME**, **BASS** and **TREBLE** controls, **B. BOOST** and **MUSIC** buttons have no effect on the recorded sound. The recording level is automatically adjusted.
- A sound field program may have effect on the recorded sound. If a sound field program is selected, cancel it before you begin recording. Refer to page 35 for how to cancel the sound field program.
- If you want to make a recording using Dolby NR, press **DOLBY NR** so that “**NR**” (②) lights up on the display. If not, turn “**NR**” (②) off.
  - \* For details, refer to “Dolby B Type Noise Reduction” on page 24.

## Basic recording

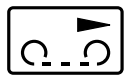
- 1 Turn on the power.
- 2 Press **INPUT**  $\triangleright$  or  $\triangleleft$  once or more to select the source you want to record.
- 3 Load a tape on the tray with side A upward.
- 4 Press **DIRECTION** or **MODE** to change the current setting if necessary.

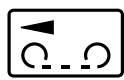
MODE	$\rightleftarrows$	$\curvearrowright$
DIRECTION	 Side A only	 Side A → Side B
 Side B only	Side B only	Side B only

- 5 Press **REC/PAUSE**.
  - \* “**TAPE REC**” (⑥) lights up on the display.
- 6 Begin playing the source to be recorded.
  - \* When playing a CD (or Video CD), the recording automatically begins a few seconds before the disc play begins. You do not need to follow step 7.
- 7 Press  $\triangleright$  of the tape deck.

### Displaying the tape counter

During recording, the information of the playing source is displayed in place of the tape counter (①). Press **DISPLAY** to change the display to the tape counter. Pressing **DISPLAY** again will restore the previous display mode.



# Recording

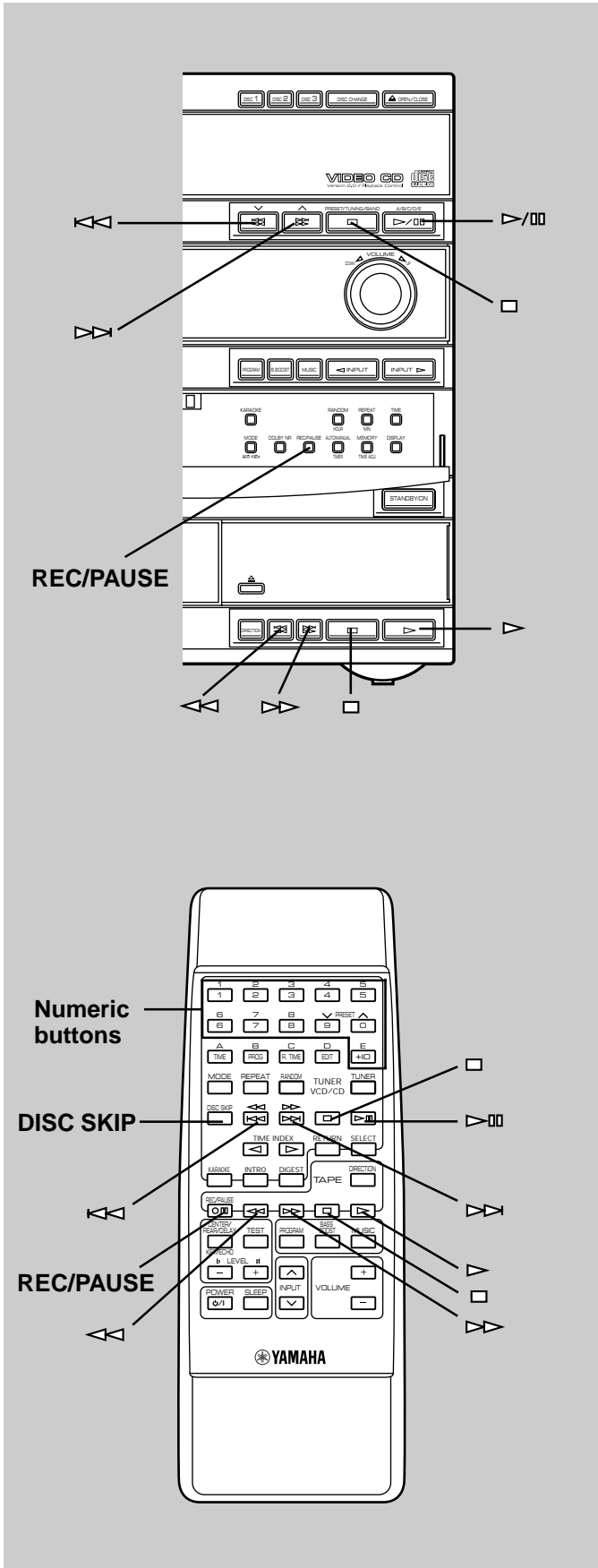

## To stop recording temporarily

Press **REC/PAUSE**.

\* Press  $\triangleright$  of the tape deck to resume recording.

## To stop recording

Press  $\square$  of the tape deck.

## To change the disc and track when recording from a CD or Video CD

**1** Press  $\square$  of the CD/Video CD player.

\* The recording stops temporarily.

**2** Select the disc by pressing **DISC SKIP** if necessary.

**3** Choose the track you want to record next by using  $\triangleright$  or  $\triangleleft$ , and then press  $\triangleright/\square$  of the CD/Video CD player to resume recording (or simply press the corresponding numeric button(s) on the remote control).

## Notes

- A sequence of tracks in the program play mode and random play mode of the CD/Video CD player can be recorded in the same way.
- During recording, by simply pressing  $\triangleleft$  or  $\triangleright$ , you can rewind the tape to the point where the recording started.
- Your singing karaoke can be recorded in the karaoke mode. (Refer to page 38 for details.)



# Recording from CDs utilizing the EDIT function

The EDIT function performs recording on both sides of the tape.

### For Video CDs

Video CDs cannot be recorded with the EDIT function.

## EDIT recording

- 1 Press **INPUT**  $\triangleright$  or  $\triangleleft$  once or more until "VCD/CD" (①) appears on the display, and load the disc to be recorded.
- 2 Select the disc by pressing **DISC SKIP**.
- 3 Load a tape on the tray with side A upward.
- 4 Select "↔" (④) by pressing **MODE**, and "▶" (③) by pressing **DIRECTION**.
- 5 Press **R. TIME** on the remote control to select the length of the tape to be used. Whenever pressed, the display changes as shown below.

(off) → C-46 → C-54 → C-60 → C-90

↑

**When using tapes other than C-46, C-54, C-60 or C-90**  
After pressing **R. TIME**, input the tape length by using the numeric buttons on the remote control.

- 6 Press **EDIT**. ("EDIT" (⑧) lights up on the display.)

The following operations are carried out automatically.

- 1) Tracks on the disc are automatically divided into side A and side B. You can check the process by watching the display.
  - \* The tape side indicator (⑨) shows the side currently selected.
- 2) If the tape is not rewound to the end, it will rewind to the end rapidly.
- 3) The end part of the tape on which recording cannot be done is wound.
- 4) Both disc play and recording starts. Recording is carried out on both sides of the tape continuously.

### Notes

- When the CD/video CD player is in the all disc play mode, if the tape's total possible recording time is longer than the total playing time of the selected disc, tracks on another disc are recorded continuously. In this case, as many as three discs can be recorded automatically.
- The CD/video CD player's repeat play mode will be canceled during this recording mode.

### To cancel the EDIT function

Before recording, press □ of the CD/Video CD player or the tape deck.

### To stop recording

Press □ of the tape deck.

(At this time, disc play automatically stops.)

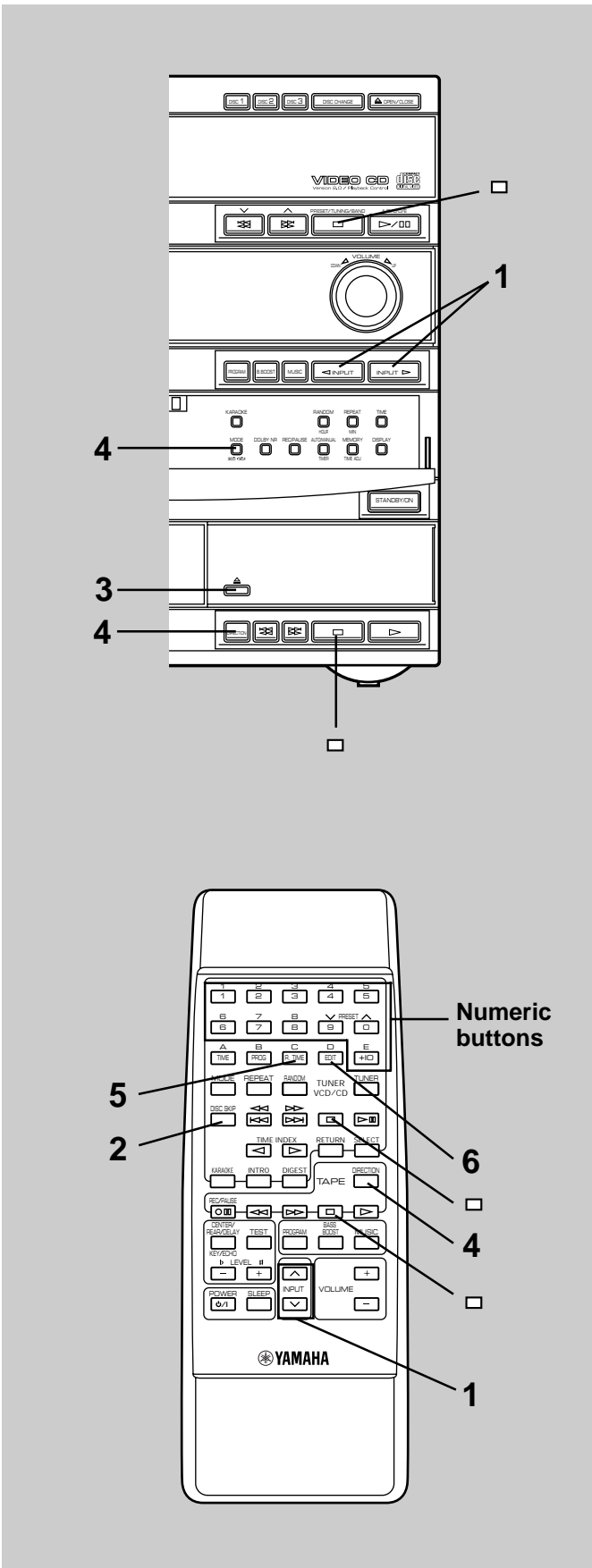

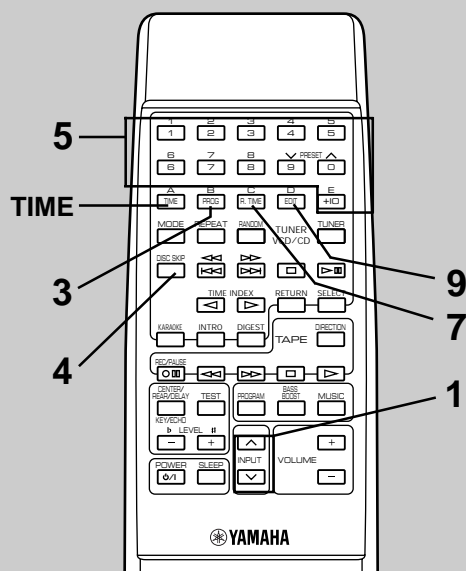
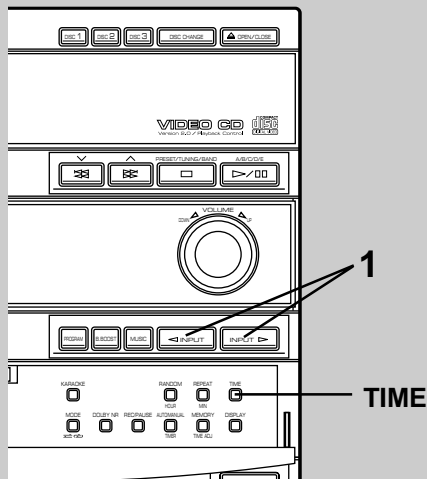

### Display information during programming

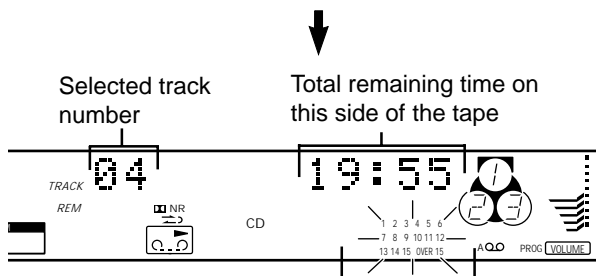
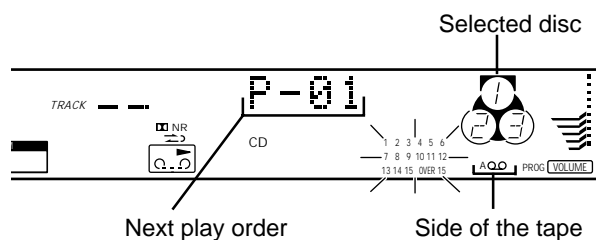

Programmed track numbers light up and only programmable track numbers among unprogrammed ones flash.

## Manual EDIT recording

You can program tracks manually while watching the remaining time on both sides of the tape.

- 1 Press **INPUT**  $\triangleright$  or  $\triangleleft$  once or more until "VCD/CD" (1) appears on the display, and load a disc (or discs) on the disc tray.
- 2 Follow steps 3–5 on page 29.
- 3 Press **PROG**.
  - \* "PROG" and "P-01" will light up on the display, and all track numbers on the selected disc will begin flashing.
- 4 If necessary, select the desired disc by pressing **DISC SKIP**.
- 5 Select the desired track number by pressing the numeric buttons.
- 6 Repeat steps 4 and 5 to program more selections for side A of the tape. You can select the same track again.
  - \* Pressing **TIME** displays the total remaining time on side A of the tape for about 1 second, and then it is replaced by the display of the next play order.
  - \* If "TM OVER" appears on the display, the track number just selected cannot be programmed because there is not enough time remaining on side A of the tape. However, at this time, if any other track number is flashing continuously on the display, you can program it instead of the unprogrammable one.
- 7 When the programming for side A is finished, press **R. TIME**.
  - \* "Side-B" appears on the display. You can begin programming for side B.
  - \* After following this step, you can check the programmed contents for side A and side B alternately by pressing **R. TIME** at any time before you press **EDIT** in step 9.
  - \* The tape side indicator (9) shows the programming side currently selected.
- 8 Repeat steps 4 and 5 to program selections for side B of the tape. You can select the same track again.
- 9 Press **EDIT**. ("EDIT" (8) lights up on the display.) The recording starts.

### Notes on recording with the EDIT function

- To check, cancel or correct program data, refer to page 15.
- The maximum number of tracks that can be programmed is 20.
- The track number 16 or higher cannot be programmed by this function.

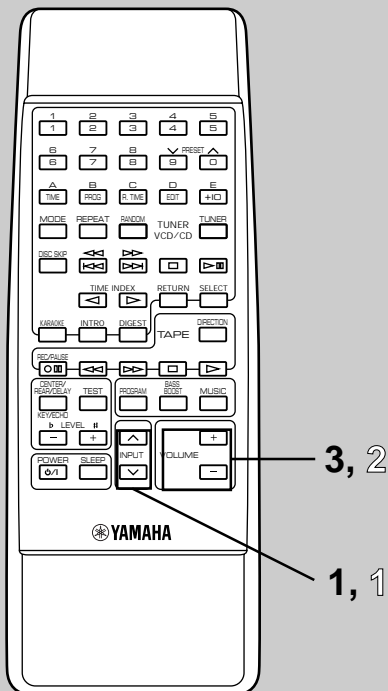
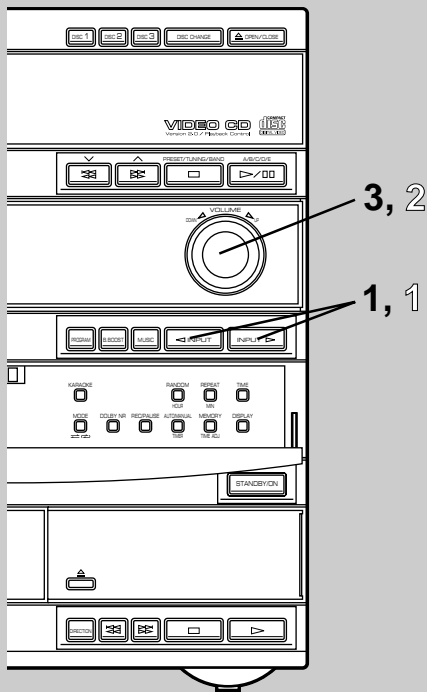

Use an external unit connected to the VCR, VIDEO or AUX/MD terminals on the rear of the main unit.

## ■ To listen to or watch a source played on an external unit connected with this system

- 1 Select the input source (VIDEO, VCR or AUX/MD) you want to play by using **INPUT** ▷ or ◁.
- 2 Play the source.
  - \* If you play a video source, turn on the TV monitor connected to this system.
- 3 Adjust the volume to the desired level by using **VOLUME**.
  - \* If you prefer, you can control the sound quality (Refer to pages 32–36) or enjoy singing karaoke (Refer to pages 37–38).

## ■ To record a source by using the tape deck, VCR etc. connected to this system

If a tape deck, VCR, etc. is connected to this system, you can record a source played on this system or an external audio/video unit connected to this system by using the tape deck, VCR, etc.

- 1 Select the source you want to record by using **INPUT** ▷ or ◁.
- 2 Play the source and then turn **VOLUME** up to confirm the input source.
- 3 Begin recording on the tape deck, VCR, etc.

### Note

- Your singing karaoke can be recorded in the karaoke mode. (Refer to page 38 for details.)
- A digital-to-digital recording is possible from a CD played on the built-in CD/Video CD player to an MD (or tape) on the MD recorder (or DAT) by connecting the DIGITAL OUT (OPTICAL) terminal on the rear of the main unit to the MD recorder (or DAT).
  - \* **For Video CDs**  
When a Video CD is played, no digital signal is output from the DIGITAL OUT terminal.

# Various sound control

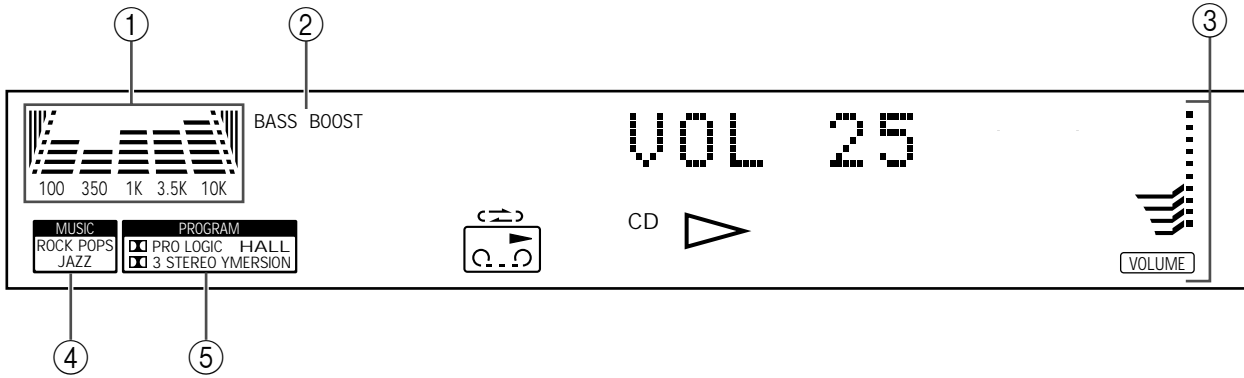

## ① Spectrum analyzer

The spectrum of the input source which is divided in five bands will be indicated in real time.

## ② BASS BOOST

## ③ VOLUME (volume level meter)

## ④ MUSIC (preset equalizer mode indicator)

## ⑤ PROGRAM (sound field program indicator)

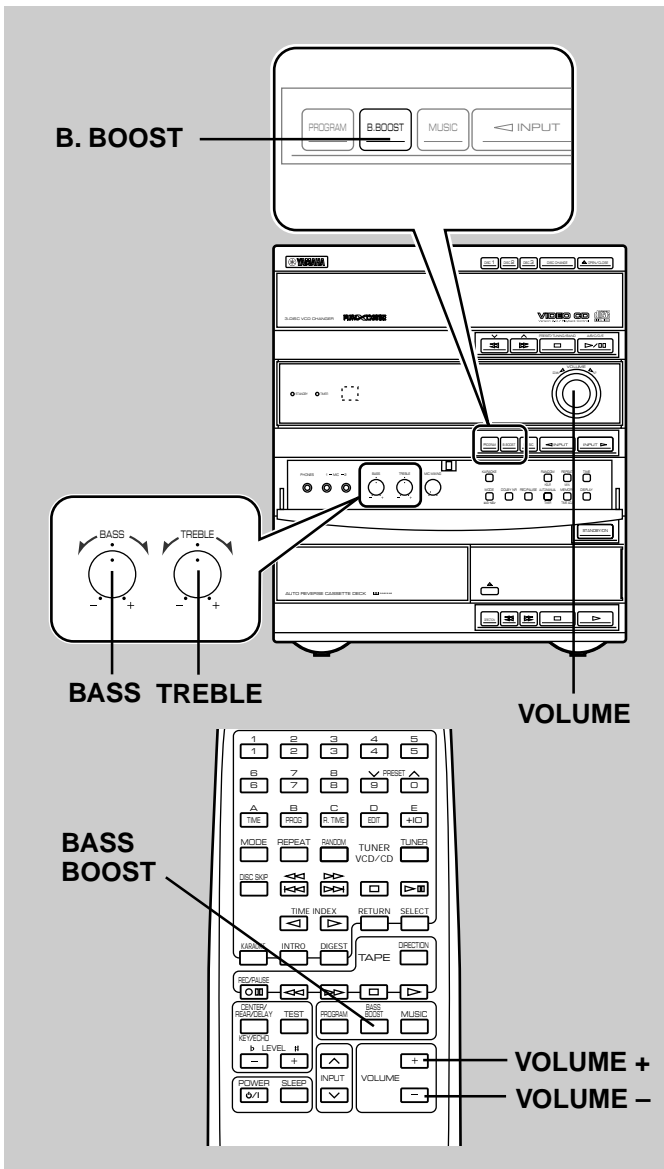

## General sound control

### ■ VOLUME control

#### Front panel operation

Rotate **VOLUME** in the “UP” direction to increase the volume, and the “DOWN” direction to decrease the volume.

#### Remote control operation

Press **VOLUME +** to increase the volume and **VOLUME -** to decrease the volume.

\* Adjusted volume level is shown by the volume level meter (③) and in figures on the display.

### ■ B. (BASS) BOOST button

Press this button so that “BASS BOOST” (②) is illuminated on the display to boost the bass frequency response of this system while maintaining overall tonal balance. This function is effective for reinforcing the bass frequencies when a subwoofer is not used.

### ■ BASS and TREBLE controls

**BASS :** Turn this knob clockwise to increase (or counterclockwise to decrease) the low frequency response.

**TREBLE :** Turn this knob clockwise to increase (or counterclockwise to decrease) the high frequency response.



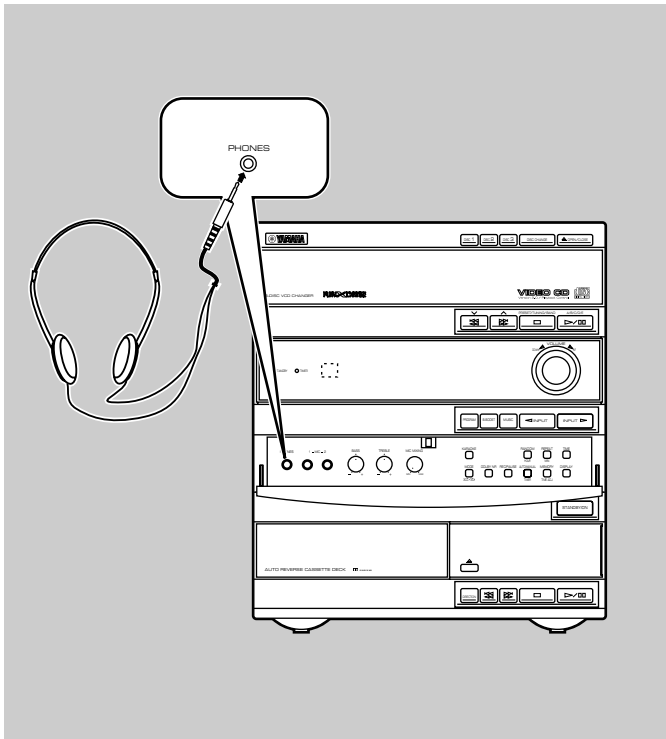

### ■ Listening with headphones

- Be sure that your headphones have a 3.5 mm (1/8") diameter plug and between 16 ohms and 50 ohms impedance. Recommended impedance is 32 ohms.
- When you listen with headphones, connect the headphones to the **PHONES** jack. You can listen to the sound that is normally output from the front speakers through headphones. Adjust **VOLUME** to a comfortable listening level.

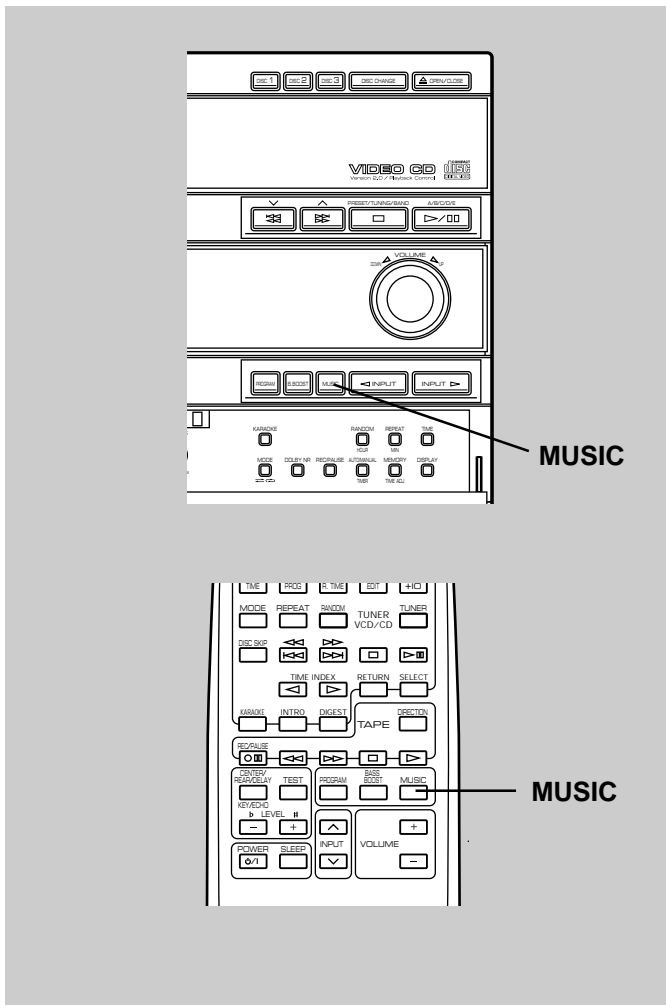

### Graphic equalizer

The built-in graphic equalizer provides 3 preset equalizer modes as listed below.

#### Preset graphic equalizer modes

Mode	Feature
<b>ROCK</b>	High and low frequencies are emphasized. This mode is suitable for reproducing dynamic and powerful sounds of rock music, etc.
<b>POPS</b>	Vocals are emphasized and whole sound is clear. This mode is suitable for pops.
<b>JAZZ</b>	High frequencies for piano, sax, etc. are emphasized. Medium frequencies for vocals are also emphasized moderately.

#### Listening to the music with a preset equalizer effect

- 1 Play back a source.
- 2 Press **MUSIC** once or more so that the name of the desired mode lights up on the preset equalizer mode indicator (**MUSIC**) (④).

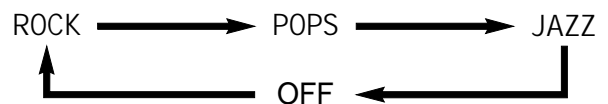



### Sound field processor

The Sound Field Processor built into this system enables you to enjoy listening to a source with an ambience of actual concert hall or three-dimensional acoustics. This system provides preset sound field programs shown below. You can enjoy an excellent sound field by selecting one of them, and adding desired adjustments.

This system also incorporates a Dolby Pro Logic Surround decoder for multi-channel sound reproduction of Dolby Surround encoded video sources. The operation of the Dolby Pro Logic Surround decoder can be controlled by selecting a corresponding sound field program.

### ■ Sound field programs

Program	Feature
 <b>PRO LOGIC</b>	This program is used for playing sources encoded with Dolby Surround. Dolby Pro Logic Surround uses four discrete channels and five speakers to reproduce realistic and dynamic sound effects: two main channels (left and right), a center channel for dialog, and a rear channel for special sound effects. The rear channel reproduces sound within a narrow frequency range.
 <b>3 STEREO</b>	This program is used for simplified play of Dolby Surround encoded sources. With this program, sound effects are output from the left and right front speakers and no sound from the rear speakers.
<b>YMERSION</b>	YMERSION is Yamaha's proprietary technology that enhances the spread of a normal stereo source play sound, creating three-dimensional acoustics using only two speakers.
<b>HALL</b>	This program presents you with an ambience of actual concert hall by adding effects as sonic reflections or reverberations that create sound environment of a hall. Sound effects are output from the front and rear speakers. Orchestra and opera music is suited for this sound field.

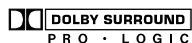

Manufactured under license from Dolby Laboratories. "Dolby", "Pro Logic" and the double-D symbol are trademarks of Dolby Laboratories.

## ■ Listening to the music with a sound field effect

- 1 Play a source.
- 2 Press **PROGRAM** once or more until the name of the desired program is illuminated on the sound field program indicator (5).  
\* Whenever you press **PROGRAM**, the program changes and is displayed as follows.

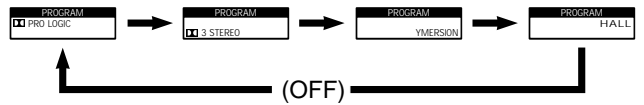

- 3 If desired, adjust the delay time and the output level of each speaker. (For details, refer to the corresponding descriptions on pages 35 to 36.)

### Notes

- When YMERSION is selected, no sound is heard from the center speaker and rear speakers.
- If you play a source not encoded with Dolby Surround when  PRO LOGIC is selected, the source may not be played normally.

## ■ Adjusting delay time and speaker output level

### DELAY TIME

You can adjust the time difference between the beginning of the sound from the front speakers and the beginning of the effect sound from the rear speakers. The larger the value, the later the effect sound is generated. This adjustment can be made to  PRO LOGIC and HALL individually.

### Control range

**PRO LOGIC:** 15, 20, 25, 30 milliseconds  
**HALL:** 15, 20, 25, 30, 40, 50 milliseconds

- 1 Press **CENTER/REAR/DELAY** once or more until "DELAY" appears on the display.
- 2 By continuously pressing **LEVEL +** or **-**, the value changes continuously.

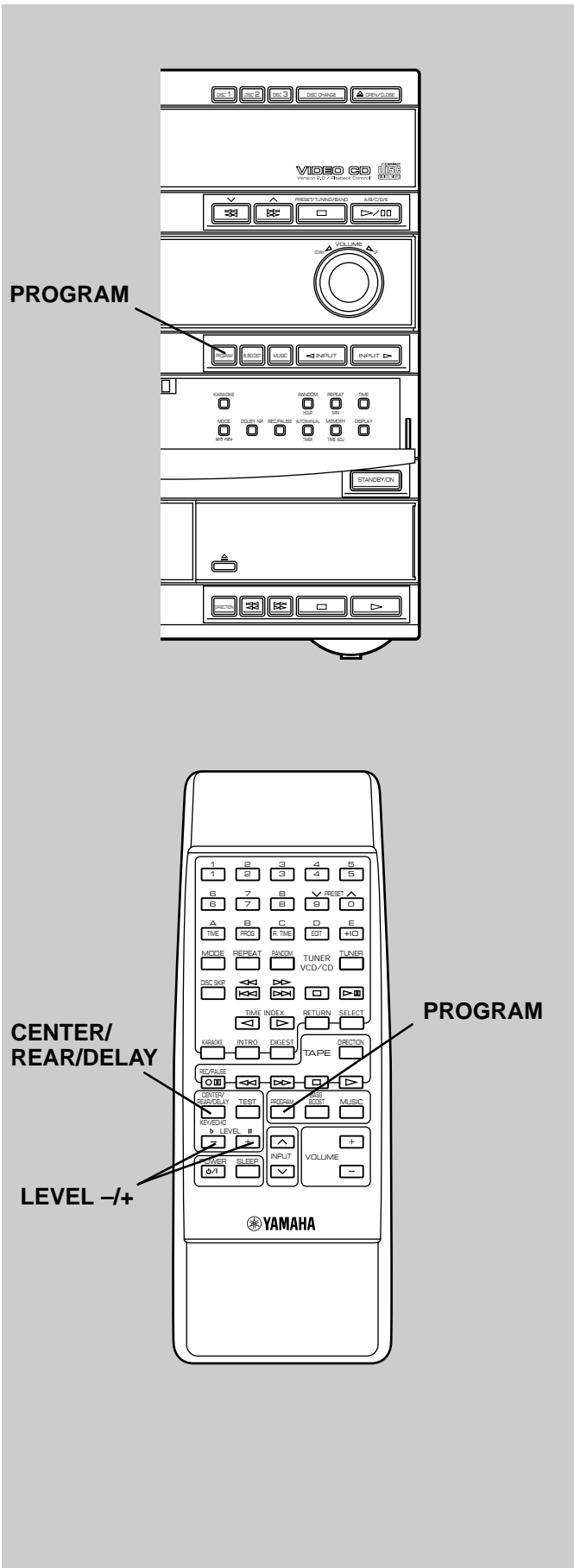
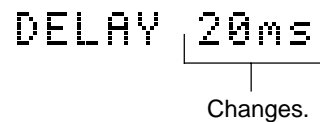



## Various sound control

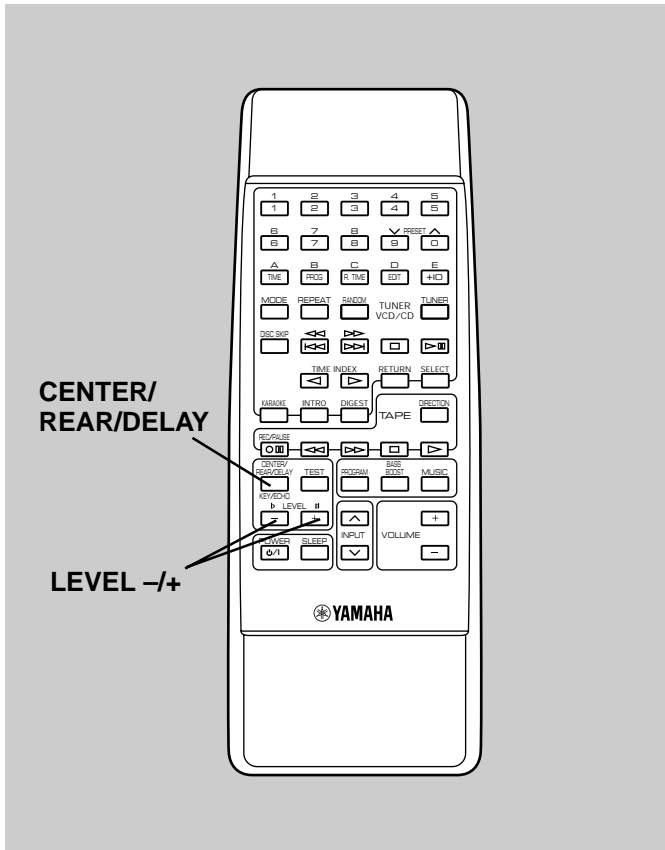

If desired, you can adjust the sound output level of the center and/or rear speakers even if the output level is already set in “Speaker balance adjustment” on page 10.

### CENTER LEVEL

**Control range :** +10 to -21

- 1 Press **CENTER/REAR/DELAY** once or more until “CENTER” appears on the display.
- 2 By continuously pressing **LEVEL +** or **-**, the level value changes continuously.

CENTER    +10  
 |  
 Changes.

#### Notes

- This adjustment can be made only when the sound field program **PRO LOGIC** or **3 STEREO** is selected.
- Once the output level is adjusted, the level value will be the same in the **PRO LOGIC** and **3 STEREO** programs.

### REAR LEVEL

**Control range :** +10 to -21

- 1 Press **CENTER/REAR/DELAY** once or more until “REAR” appears on the display.
- 2 By continuously pressing **LEVEL +** or **-**, the level value changes continuously.

REAR    +10  
 |  
 Changes.

#### Notes

- This adjustment can be made only when a sound field program **PRO LOGIC** or **HALL** is selected.
- Adjustment can be made to **PRO LOGIC** and **HALL** individually.

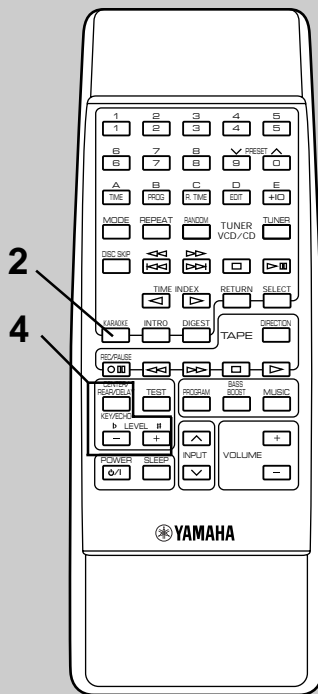
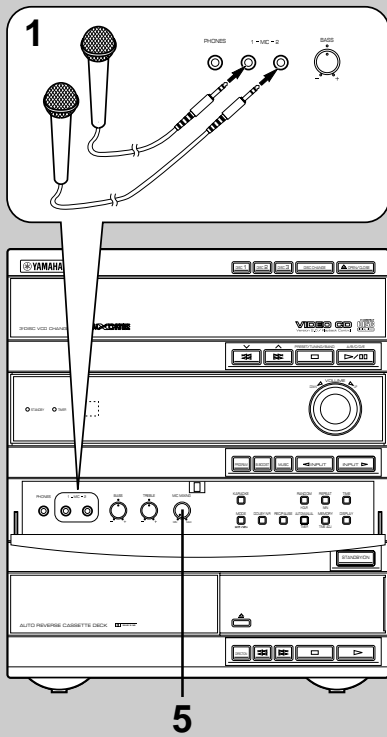

## ■ Singing karaoke

This system allows you to enjoy singing karaoke by using not only a source for karaoke use but also any normal audio source.

- 1 Connect one or two microphones to the **MIC** jack(s) on the front panel of the main unit.
- 2 Select a karaoke mode (L R, L, R or VOCAL CUT) by pressing **KARAOKE** repeatedly until the corresponding name appears on the karaoke mode indicator.
  - \* Every time you press **KARAOKE**, the karaoke mode changes and is displayed as follows.

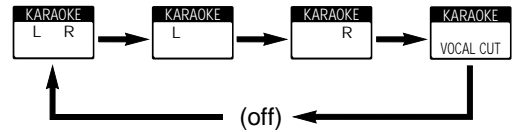

For descriptions of the karaoke modes, see the list below.

### Karaoke modes (KARAOKE)

	Mode	Feature
For a karaoke source (without vocals)	<b>L R</b> <b>(KARAOKE)</b>	Signals on the left channel and the right channel are output from the left and right speakers respectively.
For a multisound source	<b>L</b> <b>(L ONLY)</b>	Only signals on the left channel of the source are output from the left and right speakers.
	<b>R</b> <b>(R ONLY)</b>	Only signals on the right channel of the source are output from the left and right speakers.
For a normal music source	<b>VOCAL CUT</b>	Medium frequencies of the source sound (vocals etc.) are attenuated. There may be a case that vocals cannot be attenuated effectively depending on a source.

- 3 Play a source. (For playing a source, refer to page 11–26.)
- 4 If desired, adjust the level of echo effect and key of the source currently played. (For details, see the next page.)
- 5 While singing, adjust the mixing level of singing voice by turning **MIC MIXING**.

### To cancel the karaoke mode

Press **KARAOKE** once or more until no name is illuminated on the karaoke mode indicator.

### Note

The microphone(s) connected to the MIC jack(s) on the front panel of the main unit is available only when a karaoke mode is selected.



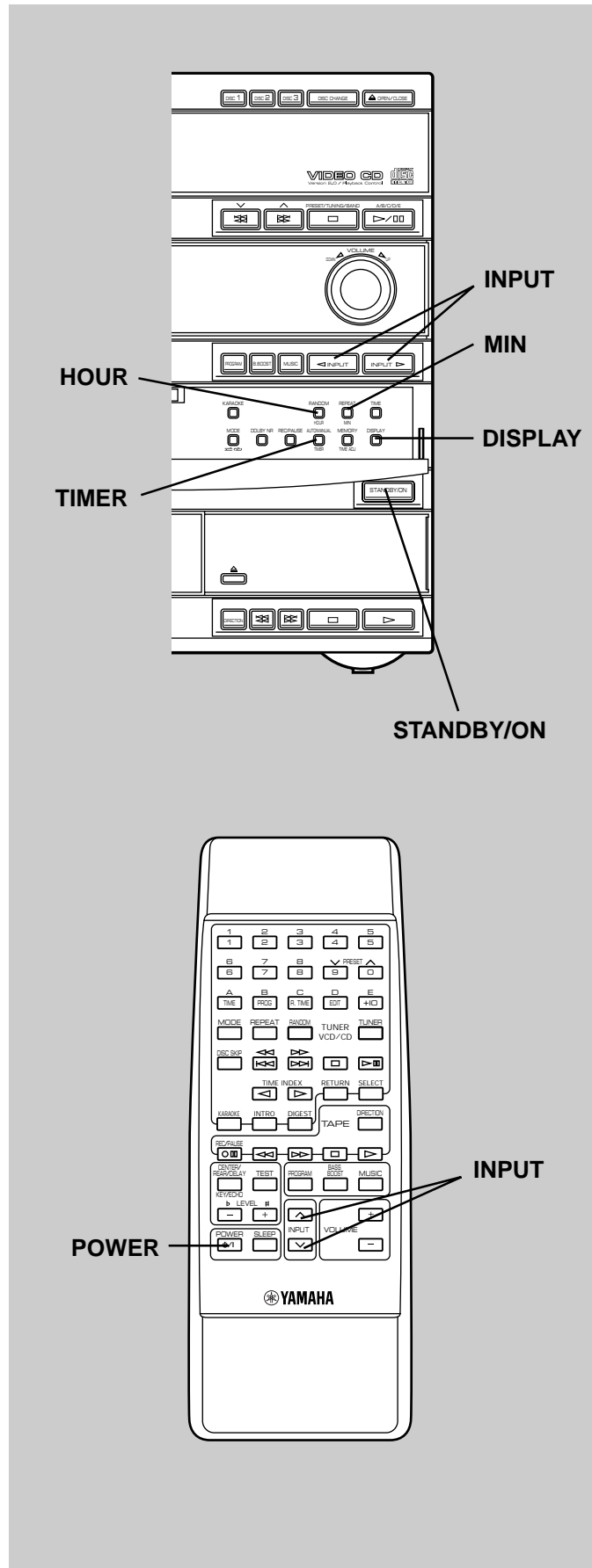

## Timer play

By using the built-in timer, you can set the time when this system turns on and a source play begins, and the time when this system will be set to the standby mode automatically.

**1** Press **DISPLAY**.  
Whenever **DISPLAY** is pressed, the display mode changes as follows.

- 1 Current time (TIMER on/off mode)
- ↓
- 2 Source selecting mode (TAPE, TUNER, VCD/CD)
- ↓
- 3 ON TIME/Time setting mode
- ↓
- 4 OFF TIME/Time setting mode
- ↓
- 5 Normal display mode

**Note**  
The display mode will change in about 8 seconds. If the mode is changed before the setting is completed, call the mode again by pressing **DISPLAY** once or more.

- 1 Current time**  
Make sure that the current time is correct, and press **TIMER** so that "TIMER" lights up on the display.
- 2 Source selecting mode**  
Select the source to be played with **INPUT**  $\blacktriangleright$  or  $\blacktriangleleft$ .
- 3 ON TIME/time setting mode**  
["ON TIME" appears on the display, and soon it is changed to a time setting mode.]  
Set the time when you want to begin the timer play.
  - Press **HOUR** and set the hour.
  - Press **MIN** and set the minute.
- 4 OFF TIME/time setting mode**  
If necessary, set the time when you want to finish the timer play in the same way as you did in step **3**. If you do not set the time, it will be automatically set so that the timer play finishes after 1 hour.

**2** Press **TIMER** to complete the timer play setting.  
This system turns into the standby mode.  
\* The **STANDBY** and **TIMER** indicators light up.

If you will continue using this system, press **STANDBY/ON** to turn on this system.

**To cancel the timer play setting**  
Press **DISPLAY**, and then press **TIMER** so that the **TIMER** indicator goes out.

**Note**  
Unless there is a power failure for more than 5 minutes, the set time will be retained until it is reset.

## Using the built-in timer

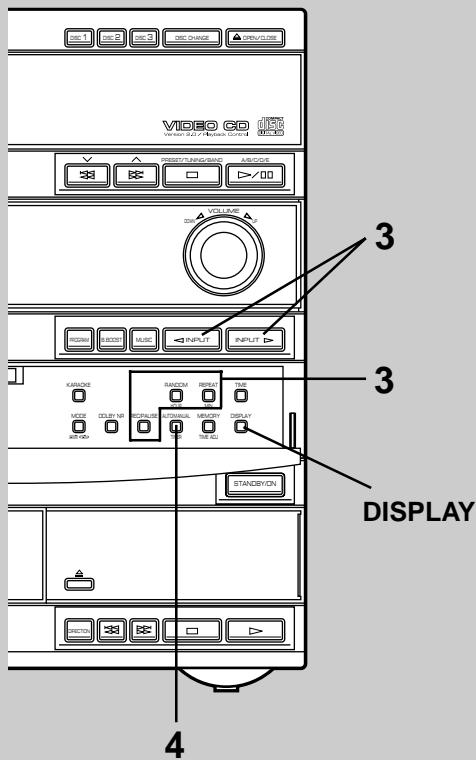

### Timer recording

- 1 Follow steps 2–3 of “Basic recording” on page 27.
- 2 Tune in to the station you want to record.
- 3 Follow step 1 of “Timer play” on page 39.
  - \* In step [2], select “TUNER”, and then press **REC/ PAUSE**. (“REC >TAPE” and the frequency will flash alternately on the display.)
  - \* In step [3], set the time when you want to begin recording.
  - \* In step [4], set the time when you want to finish recording.
- 4 Press **TIMER**.
  - This system will be set to the standby mode.
  - \* The **STANDBY** and **TIMER** indicators light up.

#### To cancel the setting of timer recording

Press **DISPLAY** once or more so that “REC >TAPE” flashes on the display. While “REC >TAPE” is flashing, press **REC/ PAUSE**.

#### Note

When the timer recording is finished, the timer setting is automatically canceled.

### Sleep timer operation

This system will be set to the standby mode automatically when the selected sleep time passes.

- 1 Play the desired sound source.
- 2 Press **SLEEP** repeatedly until the desired sleep time appears on the display. The display will change as described below.

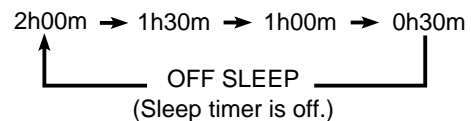

- \* The normal display mode will resume about 4 seconds after the selection is made.
- \* “SLEEP” will light up on the display.

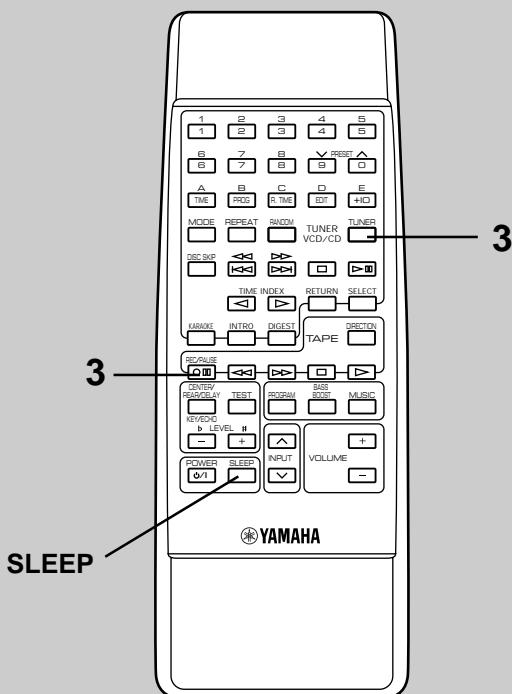



## Troubleshooting

Refer to the chart below when this system does not function properly. If the problem you are experiencing is not listed below or if the instruction below does not help, disconnect the power cord and contact your authorized YAMAHA dealer or service center.

	Problem	Cause	What to Do
General	This system does not work normally.	There is an influence of strong external noise (lightning, excessive static electricity, etc.) or the system was operated incorrectly.	Set this system to the standby mode and disconnect the AC power cord from the AC outlet. After about 30 seconds pass, connect the power and operate this system again.
	The sound suddenly goes off.	The protection circuit was activated because of a short circuit, etc.	Set this system to the standby mode, then turn on to reset the protection circuit.
		The SLEEP timer was activated.	Cancel the SLEEP timer function.
	No sound from speakers.	Speaker connections are not secure.	Secure the connections.
	No sound from the rear speakers.	The sound output level to the rear speakers is set to minimum.	Raise the sound output level to the rear speakers.
		Incorrect sound field program selection. No sound field program is selected.	Select the appropriate program.
	No sound from the center speaker.	The sound output level to the center speaker is set to minimum.	Raise the sound output level to the center speaker.
		Incorrect sound field program selection. No sound field program is selected.	Select the appropriate program.
	No sound (or no picture) from the external unit connected with this system.	Incorrect cord connections.	Connect the cords properly. If the problem persists, the cords may be defective.
		Input source selection is not correct.	Make a correct input source selection.
	Timer cannot be set.	Current time is not set.	Set current time.
This system will not operate properly.	The internal microcomputer has been frozen by an external electric shock (lightning, excessive static electricity, etc.) or power supply with low voltage.	Unplug the AC supply lead from the wall AC outlet, then plug in again after about one minute.	
The volume level cannot be increased, or sound is distorted.	The component connected to the AUX/MD OUT or VCR OUT terminals on the rear of the main unit is turned off.	Turn on the power to the component.	
A picture of the TV is disturbed.	There is an influence of magnet in the center speaker.	Place the center speaker apart from the TV.	
Tuner	Excessive static in FM broadcasts.	Interference from starting motor of nearby car.	Position the FM antenna as high and as far away from nearby roads as possible. Use coaxial cable.
		Interference from thermostat of nearby electrical appliance.	
	Noise increases during stereo broadcasts.	Antenna input is too weak due to obstructions or excessive distance from broadcasting station.	Check antenna connections.
			Install a multi-element type FM antenna if possible.
	Stereo broadcasts are noisy and STEREO indicator blinks on and off.	Insufficient antenna input.	Install an antenna appropriate for the electric field strength of your area.
	Preset stations cannot be selected.	Preset memory has been erased.	Reprogram memory presets.
	Buzzing or static during AM broadcasts.	Interference from source such as lightning, fluorescent lights, electric motors or thermostat of nearby electrical appliance.	Problem is difficult to eliminate but can be lessened by grounding AM loop antenna.
TV or microprocessor is being used nearby.		Move away from TV or microprocessor.	
AM broadcast sensitivity is poor.	Radio signal is weak or antenna is not properly connected.	Properly connect AM loop antenna.	
		Change orientation of AM loop antenna.	
		Install an external AM antenna.	

## Appendix

	Problem	Cause	What to Do
CD/Video CD player	A disc cannot be played back normally, or there is a noise during play.	The disc is not a standard type.	Play another disc.
	Play will not begin even if disc is loaded.	Disc is upside down.	Load disc label side facing up.
		Disc is dirty.	Clean disc.
	No sound or no picture.	The input source selection is incorrect.	Select the CD/Video CD player by pressing INPUT ◀ or ▶ button until "CD" is illuminated on the display.
	Sound stops suddenly (always at the same spot).	Disc is dirty.	Clean disc.
Volume is set too high.		Lower volume.	
A picture is disturbed or unstable.	Setting of the TV MODE switch on the rear panel is improper.	Set the TV MODE switch to another proper position.	
Tape deck	Tape will not move during playback or recording.	Slack tape wrapped around pinch roller.	Take up slack with a pencil before using.
	Recording is not possible.	Erasure prevention tab is broken off.	Replace tape or cover erasure prevention hole with cellophane tape.
		Head is dirty.	Clean heads.
	Sound is distorted or fades out, or stereo balance is poor.	Head is dirty.	Clean heads.
		Tape is worn.	Replace tape.
	Poor sound quality.	Tape encoded with Dolby NR is played back with this system's Dolby NR off.	Press the DOLBY NR button to turn it on.
		Tape not encoded with Dolby NR is played back with this system's Dolby NR on.	Press the DOLBY NR button to turn it off.
	Excessive noise.	Head has become magnetized.	Demagnetize heads with head eraser.
	Tape travel stops in middle of playback or recording.	Slack tape coming out of cassette shell.	Take up slack by turning reels with a pencil.
		Tape is creased or torn.	Replace with new tape.
Endless tape is being used.		Do not use endless tapes.	
The beginning of desired selections on tape cannot be found.	Silent gaps between selections are too short.	The function of searching for the beginning of desired selections will not operate unless the silent gaps between selections are at least four seconds long.	
	Excessively soft passages in middle of selections.		
	Conversation, etc. is recorded.		
Remote control	Remote control does not work.	Batteries are dead.	Replace batteries.
		Remote control is too far away or tilted too much.	Use within 6 m and 60° radius.
		Direct sunlight or lighting (of an inverter type of fluorescent lamp, etc.) is striking the remote control sensor of the main unit.	Change position of the main unit.
	TV functions strangely when the remote control is used.	Remote control is being used near TV set with a remote control sensor.	Relocate the main unit away from the TV or cover TV's remote control sensor.

## Specifications

### ■ Amplifier section

#### Minimum RMS Output Power per Channel

##### FRONT

6 ohm, 1 kHz, 0.9% THD .....	80W+80W
6 ohm, 1 kHz, 10% THD .....	100W+100W

##### CENTER

6 ohm, 1 kHz, 0.9% THD .....	80W
6 ohm, 1 kHz, 10% THD .....	100W

##### REAR

6 ohm, 1 kHz, 0.9% THD .....	25W
6 ohm, 1 kHz, 10% THD .....	30W

#### Input Sensitivity/Impedance

AUX/MD .....	200 mV/47 k-ohm
--------------	-----------------

Spectrum Analyzer Band .....	5 bands (100 Hz, 350 Hz, 1 kHz, 3.5 kHz, 10 kHz)
------------------------------	---

### ■ Video section

Video Signal Level .....	1 Vp-p/75 ohm
--------------------------	---------------

### ■ Tuner section

#### Tuning Range

FM .....	87.50 to 108.00 MHz
AM .....	[Singapore model] ..... 531 to 1,611 kHz [China and General models] .....
	530/531 to 1,710/1,611 kHz

#### Usable Sensitivity (FM)

S/N 30 dB, 1 kHz, 100% Mod. ....	1.5 $\mu$ V
----------------------------------	-------------

### ■ CD/Video CD player section

Discs Supported .....	Audio CD, Video CD
-----------------------	--------------------

Type .....	3 disc carousel auto-changer
------------	------------------------------

D/A Converter .....	1-bit DAC
---------------------	-----------

Filter .....	8-time oversampling digital filter
--------------	------------------------------------

Key Control Width .....	$\pm$ 6 steps
-------------------------	---------------

### ■ Tape deck section

Type .....	Auto reverse stereo cassette deck
------------	-----------------------------------

#### Frequency Response (-20 dB)

Type 1 (Normal) .....	50 to 15,000 Hz
Type 2 (High) .....	50 to 16,000 Hz

Wow and Flutter .....	0.09%, W.RMS
-----------------------	--------------

Signal-to-Noise Ratio .....	58 dB (Dolby NR OFF) 66 dB (Dolby B NR ON)
-----------------------------	---

Harmonic Distortion .....	0.8%
---------------------------	------

### ■ Speaker section

#### Type (Magnetic shielding type)

Front speaker .....	3-way bass reflex: 13 cm (5") woofer 5 cm (2") tweeter 2 cm (3/4") super tweeter
---------------------	--

Center speaker .....	8 (3") cm full range x 2
----------------------	--------------------------

Rear speaker .....	8 (3") cm full range
--------------------	----------------------

#### Maximum input

Front, Center, Rear .....	240W, 170W, 40W
---------------------------	-----------------

#### Impedance

Front, Center .....	6 ohm
Rear .....	12 ohm

### ■ General

#### Power Supply

[Singapore model] .....	AC 230V, 50 Hz
[China and General models] .....	AC 110/120/220/240V, 50/60 Hz

Power consumption .....	170W
-------------------------	------

#### Dimensions (W x H x D)

Main unit .....	280 x 320 x 364 mm
Front Speaker .....	200 x 320 x 218 mm
Center Speaker .....	280 x 113 x 177 mm
Rear Speaker .....	94 x 117 x 108 mm

#### Weight

Main unit .....	10.5 kg
Front Speaker .....	3.8 kg x 2
Center Speaker .....	2.0 kg
Rear Speaker .....	0.7 kg x 2

Accessories .....	Remote control Batteries Speaker cords AM loop antenna Indoor FM antenna Mounting brackets Screws Pads
-------------------	---

Specifications are subject to change without notice.

